

₹
60/-
Only

MONTHLY CURRENT AFFAIRS

September
2023

500
Puzzles
Questions



Topic wise
News

IBPS Clerk Mains Previous
Year Question Paper

SBI PO Previous
Year Question Paper

Radical **A**mbitious **W**inner



WINNER INSTITUTE

Since 2010

India's Best Banking Institute

99 22 41 6666 / 99 23 125 666

www.winnerinstitutes.com



SUCCESS: THE REWARD OF HARD WORK



Abhinav Pawar (Probationary Officer) (Working in State Bank of India)

Hello all,

I would like to share my journey of clearing SBI PO 2022. I appeared for SBI PO 2021 but was not able to clear the exam as my preparation for it was not upto the mark.

The failure in this exam ignited something in me which made me more determined and exuberant than ever.

In 2022 I almost cleared all the exams related to banking. To name a few I cleared IBPS Clerk, appeared for IBPS PO Interview but could not make it and after a few weeks I joined SBI as a Junior Associate before clearing SBI PO 2022.

According to my limited understanding any bank exam can be cleared within 12-14 months if you have proper guidance.

I mostly did self-study for prelims and mains but for the Interview round I enrolled myself in Winner Institute. After going through the briefing session and a few other sessions I realised that there are a lot of things which can't be done alone.

Mrudul Ma'am and Abhay Sir gave priceless knowledge to us. They not only told us how to tackle the interview but also enlightened us on what to do and what not to do after getting selected.

The extensive mock interview sessions that the institute conducted not only checked, improved and polished my knowledge but also gave me insights into minute details like how to sit for the interview, what should be the tone of my voice, attire, etc. Abhay sir always told us to have a smiling face even if the interviewer is grilling you. This was the mantra that I followed in my SBI PO interview.

The standout thing of Winner Institute is that they help you in developing your personality holistically.





Index

Sr. No.	Topic Name	Page No.
01.	Banking and Financial Awareness	03
02.	National Affairs	12
03.	International Affairs	21
04.	Books and Authors	25
04.	Summit and Conference	27
05.	Report and Ranking	30
06.	Sports	31
07.	Awards	36
08.	Appointment	38
09.	Defence related News	41
10.	Obituaries	43
11.	Days and Themes	45
12.	Government Schemes	49
13.	SBI PO Prelims (Memory based Paper)	51
14.	IBPS PO Mains (Memory based Paper)	63
15.	Puzzles + Seating Arrangement 500 Questions	82





Banking and Financial Awareness

1. Yes Bank has launched a co-branded Corporate Credit Card named '**Yes Bank Zaggie Corporate Credit Card**' in collaboration with the spend management platform **Zaggie**, a company specialized in spend management.

The aim is to empower businesses to redefine their corporate payments, expenditure management, and cash flow optimisation.

2. The Life Insurance Corporation of India (LIC) has collaborated with Mumbai-based **Saraswat Cooperative Bank**, India's largest urban cooperative bank, to increase the penetration of life insurance products through Bancassurance channel.

3. DBS Bank Ltd (formerly known as Development Bank of Singapore Limited), in collaboration with Maptrusco, a Singapore-based commodities trader, has completed the **first live transaction of electronic Bills of Lading (eBL)** for shipments between Singapore and India.

The transaction has been implemented under the Trade Trust framework, an initiative by the Infocomm Media Development Authority (IMDA) and supported by Enterprise Singapore.

4. The Asian Development Bank (ADB) has approved **Rs.3.32 crore** to a team of technology experts from **BITS Hyderabad, IIT Bombay, and IIT Kharagpur** to develop, test, and implement passenger safety projects in the public transport systems of Hyderabad.

BITS Hyderabad, IIT Bombay, and IIT Kharagpur experts, led by Prof. Prasanta Sahu, are working on developing technology solutions to improve last-mile security for metro rail and public transit passengers under the guidance of MD of Hyderabad Metro Rail Limited (HMRL) N.V.S Reddy.

5. Bandhan Bank has been appointed by the Reserve Bank of India (RBI) to act as an authorised pension disbursement bank on behalf of the **Central Pension Accounting Office (CPAO)** for the civil pensioners.

The bank will soon be integrating with the office of CPAO, Ministry of Finance, to operationalize the disbursement process.

The authorisation entitles the bank to disburse pensions to the central government employees in civil ministries/departments (other than railways, posts, and defence), National Capital Territory of Delhi,

Union Territory Administrations without legislatures, retired judges of the high courts and the Supreme Court and All India Service Officers.

This scheme also covers payment of pensions to former Members of Parliament and the payment of pension and other amenities to former presidents/ Vice Presidents of India.

6. PhonePe has entered the stock broking business with the launch of a new mobile application called '**Share(dot)Market**', under its subsidiary **PhonePe Wealth Broking**.

- The Share(dot)Market app elevates the discount broking by providing market intelligence and quantitative research based WealthBaskets, a scalable technology platform.
- The app will provide a wide spectrum of investment products, including stocks (intraday and delivery), mutual funds, exchange-traded funds (ETFs), and WealthBaskets.

7. Dipak Gupta, Joint Managing Director of **Kotak Mahindra Bank**, has been appointed as the **interim MD & CEO** of the bank till 31st December 2023. He will hold the position till Reserve Bank of India (RBI) proposes its successor.

His appointment follows the early resignation of Uday Kotak from the position of MD & CEO with effect from 1st September 2023.

8. The Asian Development Bank (ADB) has signed an agreement of worth **Rs.1.2 billion** (about USD 14. million) with **Fourth Partner Energy Private Limited**, an Independent Power Producer (IPP), to build and operate a **25-megawatt** solar photovoltaic-based power plant.

The aim is to increase clean and low-cost energy supply to commercial and industrial customers.

The power plant, located in **Tirunelveli** district in the state of **Tamil Nadu**, is expected to generate about **50.7 gigawatt-hours** of electricity annually and will directly sell power to commercial and industrial users.

9. Indian Bank has collaborated with **OneCard** to introduce state-of-the-art, mobile-first, contactless, **VISA Signature** metal cobranded credit cards. The objective is to provide easy access to potential users in the wake of social distancing.

The card offers real-time transactions tracking, spends management, EMI conversion, reward





redemption, repayments, monthly budget planning to credit limit adjustments and seamless payments.

10. Bajaj Allianz Life Insurance has launched a new savings plan '**Bajaj Allianz Life ACE**', a non-linked, participating, early-income life insurance plan designed to offer enhanced flexibility to customers in tailoring their cash flows according to their individual financial needs.

Key features:

- **Minimum & Maximum Age at Entry: 18 to 55 years** (with Goal Protection Benefit (GPB)) & **0 to 60 years** (without GPB).
- **Maturity Age:** upto 85 years (with GPB) & upto 100 years (without GPB).
- **Premium payment:** yearly, half-yearly, quarterly, and monthly
- The plan offers flexibility in choosing the income tenure, ranging from a minimum of 10 years up to the age of **100 years**.
- The insurer will receive a lump-sum on maturity.
- The insurer will receive income in arrears.
- The plan provides an extra income benefit exclusively for women, empowering them to plan for their life goals with added financial security and flexibility.
- The insurer will receive income in the form of Cash bonuses from the end of 1 month/1 year after the Deferment period of the policy.
- The policyholder can opt to receive income right away or can delay it for up to 5 years.

11. Hitachi Payment Services, India's leading payments and commerce solutions provider, has launched **India's first-ever UPI (Unified Payments Interface)-ATM as a White Label ATM (WLA)** in association with National Payments Corporation of India (NPCI), offering secure card-less cash withdrawals.

At present, Hitachi payments is **the only WLA operator** to offer cash deposit facility.

White Label ATM (WLA):

ATMs set up, owned and operated by non-banks are called WLAs. Non-bank ATM operators are authorized under the Payment & Settlement Systems Act, 2007 by the Reserve Bank of India (RBI).

12. Pay Nearby has teamed up with the **Grameen Foundation for Social Impact (GFSI)** to upskill **1.50 lakh business correspondents (BCs)** across India

and enlist **15,000 women BCs** through the required skills, knowledge, and support in rural India.

The collaboration aims to provide digital and financial services to the underserved and techshy last-mile population.

As part of this collaboration, PayNearby and GFSI will launch a pan-India scale-up project titled '**Scaling Agent Viability and Quality in India**' supported by the Bill and Melinda Gates

Foundation (BMGF).

The initiative will be completed over the span of the next two years.

13. The Government has allowed the **Employees Provident Fund Organization (EPFO)** to invest proceeds from the sale or redemption of investments in equities and related assets.

EPFO can now invest a minimum of **5%** and a maximum of **15%** in equities and related instruments. EPFO can invest in shares of companies listed on Bombay Stock Exchange (BSE) or National Stock Exchange (NSE) with a market capitalisation of Rs.5000 crore or more.

Investments can also be made in mutual funds with a minimum of 65% of their investments in BSE or NSE listed equity.

EPFO can invest in shares of Exchange-Traded Funds (ETFs)/Index Funds replicating the BSE Sensex Index or the NSE Nifty 50 Index.

EPFO does not directly invest in individual stocks, including blue-chip companies.

14. Bajaj Auto Consumer Finance Limited (BACFL), a wholly-owned subsidiary of Bajaj Auto, has received a certificate of registration from the Reserve Bank of India (RBI) to carry out operations as a non-deposit taking **Non-Banking Financial Company (NBFC)**.

The certificate of registration has been issued on 31st August 2023 under Section 45-IA of the RBI Act 1934 to commence on the business of the NBFC without accepting public deposits.

BACFL is the 2nd NBFC in the Bajaj group.

15. Ashok Leyland, a commercial vehicle maker, has tied up with **CSB Bank Limited** to provide vehicle financing solutions to its customers. The partnership with CSB Bank will benefit customers with financial products, which are specifically tailored for a hassle-free experience.





16. ICICI Prudential Life Insurance has launched an innovative income plan, **ICICI Pru GIFT Pro**, which provides customers the option to receive either a year-on-year increasing income or a constant regular income.

The plan offers a range of premium payment terms from **5 to 12 years**.

The plan will start giving income for as long as 30 years from the eighth year onwards.

The life cover part will provide financial security to the family.

The plan offers a minimum annual premium of Rs.50000.

The minimum age at entry is 18 years (minus Policy term) and maximum is 60 years.

Under the circumstance of the policyholder's demise during the income period, the nominee will continue to receive the income.

17. The **Securities and Exchange Board of India (SEBI)** has reconstituted its Alternative Investment Policy Advisory Committee that advises it on a range of issues impacting further development of the **AIF (Alternative Investment Fund)** space.

- The committee, constituted in March 2015 and had 20 members when it was last rejigged by the regulator in February 2022, has now **25 members**.
- The committee is chaired by Infosys co-founder **N R Narayana Murthy**.

18. Punjab National Bank has launched the **PNB GST Sahay App**, a mobile application based on the Goods & Services Tax (GST) Sahay scheme. This is an end-to-end digital product under which lending can be done using GST invoices.

With this, PNB has become the **first public sector lender** to facilitate digital credit flow to Micro, Small, and Medium Enterprises (MSMEs) using GST invoices. Through this app, all GST-registered MSMEs having an active account with PNB will be able to access the bank's GST Sahay service for loans starting from Rs.10,000 to Rs.2 lakh per invoice, subject to capping of Rs.10 lakh per borrower.

19. Savart, one of India's largest investment advisors, has launched its maiden and flagship Portfolio Management Service (PMS), **'The Ad Astra Fund'**, the **world's first fully automated investment fund**, in Hyderabad, Telangana.

It uses Artificial Intelligence (AI) research system APART (Advanced Process Automation & Research Technology) to make investment decisions.

20. Shivalik Small Finance Bank has partnered with fintech infrastructure company **Falcon** to develop futuristic and industry-first financial products. These products include fully digital and instant Digital FDs and Savings Accounts, among other upcoming product lines.

21. Paytm has launched the **'Card Soundbox'**, India's first soundbox that will accept all domestic & international card payments. This will enable merchants to accept both mobile and card payments across all Visa, Mastercard, Amex and RuPay networks through Soundbox with **'tap and pay'** feature.

Paytm Card Soundbox has a built-in 'tap and pay' functionality through which merchants can accept card payments up to Rs.5,000.

It is powered by 4G network connectivity providing fastest payments alerts.

It provides alerts in 11 languages, which can be easily customised through the Paytm for Business app.

22. US-based **GQG Partners** has acquired **5,07,39,653 shares** (0.8% of the total equity) in **IDFC First Bank** for about Rs.478.70 crore from MD & CEO V Vaidyanathan in a block trade transaction.

Vaidyanathan's shareholding in IDFC FIRST Bank is set to rise from 0.58 per cent as of June 30, 2023, to 1.04 per cent of the paid-up capital.

23. Bharti AXA Life Insurance has introduced **'Bharti AXA Life Income Labh'**, an individual savings plan that provides both financial security and a consistent income stream throughout the policy term.

24. Mastercard has introduced its flagship lifestyle platform, **'Priceless.com'**, with the support from the **Ministry of Tourism** and **Invest India** to explore India's history and culture by using latest travel trends.

'Priceless.com' will support the **'Dekho Apna Desh'** initiative of the Ministry of Tourism.

25. The **Hongkong and Shanghai Banking Corporation (HSBC)** India has introduced **'ONDC in a Box'** to offer an **'Open Network for Digital Commerce (ONDC)'** enabled proposition. With this launch, HSBC India has become the **first foreign bank** in India to offer an ONDC-enabled proposition.





ONDC in a Box is developed in association with Protean eGov Technologies Ltd (Protean) and Shayr Omnichannel Private Limited (Adya).

Open Network for Digital Commerce (ONDC):

It is an initiative by the Department for Promotion of Industry and Internal Trade, and Ministry of Commerce and Industry to build an open, interoperable network on which buyers and sellers can transact without needing to be present on the same platform.

ONDC aims at fostering an inclusive, competitive, and open network, amplifying its impact across the business spectrum.

26. Cashfree Payments, a payments and banking technology company, has launched '**AutoPay on QR**' in collaboration with the National Payments Corporation of India (NPCI).

27. The **National Bank for Agriculture and Rural Development (NABARD)** has inked a Memorandum of Understanding (MoU) with the **United Nations Development Programme (UNDP) India** to co-create data-driven innovations in agriculture and food systems to support smallholder farmers.

This MoU aims to enhance and disseminate collaborative digital public goods like **DiCRA (Data in Climate Resilient Agriculture)**.

DiCRA, which is curated by UNDP and partner organisations to inform public about investments in agriculture, provides open access to key geospatial datasets pertinent to climate resilient agriculture.

28. The **State Bank of India** has launched the "**RuPay NCMC Prepaid Card**" to facilitate easy digital ticketing fare payments in metro, buses, water ferries, parking, etc., through a single card.

Customers can also use the National Common Mobility Card (NCMC) for making retail and ecommerce payments.

The card has been launched at the Global Fintech Fest 2023 held in Mumbai, Maharashtra.

29. The Competition Commission of India (CCI) has approved the acquisition of up to **29.9 percent** equity stake in **RHI Magnesita NV by Ignite Luxembourg Holdings Sàrl**.

The proposed combination leads to an indirect acquisition of RHI Magnesita India Limited (RHIM India) as no shares of the Indian company were purchased.

30. AU Small Finance Bank has introduced the '**Zenith + Super Premium Metal Credit Card**'.

This credit card includes features like premium lounge access, personalised concierge services, and a welcome with Premium Brand vouchers or Reward Points worth Rs.5000.

SBI Funds Management Limited has acquired an approximately **8% stake** in online gaming firm **Nazara Technologies Ltd** for a cash consideration of **Rs.410 crore**. This also follows Rs.100 crore investment by Nikhil and Nithin Kamath, the founders of India's largest brokerage Zerodha Broking Ltd.

The funds have been invested via three schemes of SBI Mutual Fund, namely SBI Multicap Fund, SBI Magnum Global Fund and SBI Technology Opportunities Fund.

31. Cleartrip, a Flipkart company, has collaborated with **Axis Bank** to introduce travel benefits to all the existing and new Axis Bank credit cardholders while booking through the online travel aggregator's platform.

Under this collaboration, Axis Bank credit cardholders can get travel offers and benefits without having to wait for collecting points.

This will include features such as flexible bookings, cancellation options and date changes, all without any additional costs.

32. Union Bank of India (UBI) has introduced two new Debit Card variants, the **High Networth Individuals (HNI) Emperio RuPay Metal Debit Card** and the **RuPay Empower Her Debit Card**, in collaboration with the National Payments Corporation of India (NPCI).

Both the cards are issued on the **Rupay network**. With this, UBI has become the **first public sector bank (PSB)** to offer metal debit cards, serving High-Net-Worth Individuals (HNIs) and women customers.

33. SBI Card, India's largest pure-play credit card issuer, has introduced the '**SimplySAVE Merchant SBI Card**', a specialized credit card tailored for Micro, Small, and Medium Enterprises (MSMEs).

This card operates on the RuPay network and can be linked to UPI for payments through UPI-enabled third-party apps.

The card offers short-term credit options and other exclusive benefits.

34. Mastercard has teamed up with **KredX**, India's leading supply chain finance provider, to transform





B2B (business-to-business) digital payments, ensuring benefits for both enterprises and vendors. Under this association, Mastercard will integrate its commercial card services into the KredX platform, effectively streamlining the intricacies commonly associated with B2B payments, especially those involving cards.

35. Bank of India has launched a Universal App named **"BOI Mobile-Omni Neo Bank"** during the celebration of its **118th Foundation Day** on 7th September 2023. The app will offer more than 200 services to customers.

This application will make customers to enjoy 360-degree banking facilities along with investments, payments/ remittances, shopping and managing all accounts seamlessly.

80. REC Limited, the Maharatna Central Public Sector Enterprise under the Ministry of Power, has signed a Foreign Currency Term Loan Agreement for **USD 100 Million**, with **Export**

Import Bank of India (EXIM Bank).

- The funds will be raised as part of REC's Market Borrowing Programme of Rs.1.20 lakh crore for the year 2023-24.
- This is the first term loan being extended by EXIM Bank to REC.
- The loan has been tied up for a 5-year tenor and is benchmarked to SOFR (Secured Overnight Financing Rate), which is the benchmark rate for the loans denominated in USD.

REC Limited has committed to increase its green project loan portfolio to Rs.3 lakh crore by 2030, representing more than a 10-fold increase.

36. IndiaFirst Life Insurance Company Limited (IndiaFirst Life) has introduced a novel offering named **'IndiaFirst Life Guaranteed Single Premium Plan'**, a non-linked, nonparticipating, individual, single premium savings plan, which offers guaranteed returns to the customer over a long policy term.

The plan guarantees up to 7x returns for a 30-year policy term.

The customers have the flexibility to select their desired life cover option from a range of choices, including a life cover of 1.25 times or 10x against the single premium.

37. Aditya Birla Capital Digital Limited, the wholly owned subsidiary company of Aditya Birla Capital Limited, has introduced **'Payment Lounge'**, an

omnichannel, multi-mode collections platform, in association with **PhiCommerce**.

The objective is to enable merchants to provide a unified, secure, and faster transaction experience to their customers for making digital payments.

The Payment Lounge is underpinned by PhiCommerce's omnichannel payment platform PayPhi – a one-stop solution that serves businesses' diverse payment needs across both online and offline channels.

38. The Indian Renewable Energy Development Agency (IREDA), a Mini Ratna (Category - I) Government of India enterprise under the administrative control of Ministry of New and Renewable Energy, has signed a **Memorandum of Understanding (MoU)** with **Bank of Maharashtra (BoM)** to promote and facilitate co-lending and loan syndication for a diverse spectrum of Renewable Energy projects across India.

Under this MoU, BoM can invest in the Bonds issued by IREDA in accordance with the specified terms and conditions of the offering.

39. Bharti AXA Life Insurance has launched its New Fund Offering (NFO) called **"Bharti AXA Life Emerging Equity Fund."** This is Bharti AXA's **first mid-cap fund** to provide long-term capital appreciation through investing in a portfolio of mid-cap companies.

This mid-cap fund will offer higher returns, productivity, and profitability and will also have more growth potential.

40. The State Bank of India (SBI) has introduced a digital facility for **Non-Resident Indians (NRIs)** to effortlessly open NRE and NRO accounts (both savings and current accounts) through its mobile app YONO. This service is designed for NTB or **'new to bank'** customers, providing them with ease and efficiency in the account opening process.

Note: A **Non-Residential External (NRE)** account is a bank account opened in India in the name of an NRI, to park his foreign earnings; whereas, an **Non-Resident Ordinary (NRO)** account is opened in India in the name of an NRI, to manage the income earned by him/her in India.

41. Startup Odisha, a programme by the MSME Department of the Odisha government, has launched a **Rs.100 crore Odisha Startup Growth Fund (Fund**





of Funds) in collaboration with Small Industries Development Bank of India (SIDBI).

The state government would replenish the fund once the Rs.100 crore corpus is allocated.

SIDBI will serve as the fund manager for the new fund and will be responsible for framing the investment strategy and managing the fund's portfolio.

42. The **National Payments Corporation of India (NPCI)** has launched the "OTG Ring" which is the first contactless payment wearable ring made in India, in collaboration with fintech startup **LivQuik**.

"OTG Ring" can be enabled for **National Common Mobility Card (NMC)** customers.

This will allow users to make payments to any **Near Field Communication (NFC)**-based device and aims to replace plastic cards for various open-loop transit programs.

Other collaborations:

- NPCI has partnered with the **Indian Highway Management Company Limited (IHMCL)** to launch **EV (Electric Vehicles)** charging payments on the **National Electronic Toll Collection (NETC)** FASTag platform.
- NPCI has also launched a **prepaid gift card** in partnership with the state-backed payments network RuPay as well as a separate personalised prepaid card in collaboration with **Pepper Money and PineLabs**.
- The NPCI has also unveiled a **prepaid card** in collaboration with **FamX**, primarily targeted at Gen Zs.

43. **Juspay**, India's leading payments company, has joined hands with **Yes Bank** to launch **HyperUPI**, a plug-in service developed by the **National Payments Corporation of India (NPCI)** that empowers in-app **UPI (Unified Payments Interface)** payments for merchant apps.

With this, the merchants can now offer customers a hassle-free one-click UPI experience using Android and iOS-based smartphones without switching to an external UPI-based app.

44. **Max Life Insurance**, a private life insurer, has entered the health and wellness segment with the launch of a new plan, "SEWA". The **Secure Earnings & Wellness Advantage (SEWA)** plan covers hospitalisation, ICU stay, surgeries, critical illness, and disability, besides life cover.

To drive insurance adoption among women and transgender customers, as part of financial inclusion, it offers 5 percent discount in the first-year premium. The plan provides customers with access to Max Fit wellness digital app, which incentivises leading a disciplined and healthier lifestyle through enhanced maturity benefits.

45. Union Minister for Skill Development & Entrepreneurship, Dharmendra Pradhan, has launched 'Skills on Wheels' initiative in collaboration with the **National Skill Development Corporation (NSDC)** and **IndusInd Bank**.

Under this collaboration, **60,000 youth** will be empowered over a period of **five years** with the objective of improving livelihood of rural households by providing relevant skills training to its youth population.

A customized bus with retrofitted tools will promote the 'Skill India Mission' initiative through 'Skills on Wheels'.

Note: Skill India Mission was launched in 2015 to help India become 'Atmanirbhar.'

46. **Mastercard India** has appointed **Rajnish Kumar**, former Chairman of the State Bank of India, as its non-executive chairman. In this role, he will guide the South Asia executive leadership team in navigating the domestic payments landscape.

He is currently serving as the Chairman of payments start-up BharatPe.

He served as the Chairman of SBI from 2017 to 2020.

47. The **Ministry of Finance** has approved a series of welfare measures for the benefit of **Life Insurance Corporation of India (LIC)** agents and employees.

The welfare measures are related to the amendments to **LIC (Agents) Regulations, 2017**, Enhancement of Gratuity Limit, and Uniform Rate of Family Pension among others.

- The **gratuity limit** for LIC Agent has been raised from **Rs.3 lakh to Rs.5 lakh**.
- The **term insurance cover** has been expanded from the existing Rs.3,000- Rs.10,000 to **Rs.25,000-Rs.1,50,000**.
- **Reappointed agents** will now be eligible for **renewal commission**, thereby providing them with increased financial stability. Currently, LIC agents are not eligible for renewal commission on any business completed under the old agency.
- The family pension will be provided at a uniform rate of **30%**.





These measures will benefit more than 13 lakhs agents and more than 1 lakh regular employees of LIC.

48. Euler Motors, a commercial electric vehicle company, has collaborated with the **Small Industries Development Bank of India (SIDBI)** for “**Mission 50K-EV4ECO**” program. The aim is to revolutionize the electric vehicle (EV) financing segment, strengthen the electric mobility ecosystem, and pave the way for a sustainable future.

Euler Motors will facilitate financing and deployment of over 2000 of its class leading HiLoad EV, over the next two years.

“Mission 50K-EV4ECO”:

It is the flagship scheme of SIDBI to lift electric vehicle adoption across the country. As part of this mission, SIDBI is providing loans for the purchase of EVs and developing charging infrastructure, including battery swapping, to eligible small and medium enterprises (SMEs).

49. IndusInd Bank has launched a '**Virtual Commercial Credit Card**' in collaboration with **Visa and Juspay** with additional layers of security to give the cardholders complete control over cross-border transactions for corporates and travel agents.

The card is built on the Visa Payables Automation platform.

The card benefits the customers who make multiple bookings in different foreign denominated currencies. The card offers a high degree of control, reduced complexity, and complete transparency.

50. Mumbai-based **BriskPe**, a cross-border payments FinTech company, has recently (in September 2023) tied up with **YES BANK** to launch "**BriskPe Account-to-Account (A2A)**", an innovative suite of solutions designed to empower exporters and importers.

This collaboration marks a significant milestone in the domain of cross-border payments, providing a seamless and efficient platform for Indian businesses to navigate the intricacies of international trade and bolster their global competitiveness.

51. The **Indian Institute of Technology (IIT)**, Kanpur has signed a Memorandum of Understanding (MoU) with **ICICI Bank** to provide start-ups with a comprehensive support system.

The aim is to empower start-ups and innovators at the Start-up Incubation and Innovation Centre (SIIC) IIT Kanpur with essential tools and knowledge.

52. Tata Power Solar Systems Limited (TPSSL) has inked a Memorandum of Understanding (MoU) with the **Small Industries Development Bank of India (SIDBI)** to provide accessible financing options to micro, small, and medium enterprises (MSMEs) looking to adopt solar solutions.

This MoU aims to promote solar energy adoption among MSMEs by providing tailored and innovative financing solutions through SIDBI's 4E (End-to-End Energy Efficiency) Scheme, which offers competitive interest rates and flexible loan limits, catering to the specific needs of the MSME sector.

Additionally, TPSSL and SIDBI have also introduced '**The Big Solar Fest**' at the Global SME Finance Forum 2023 in Mumbai. The aim is to drive awareness about competitive financing options with no processing fees, further accelerating the transition towards green energy in the MSME sector.

53. The **Central Bank Digital Currency (CBDC)** or e-rupee worth **Rs.16.39 crore** is in circulation as of March 2023, according to data from RBI's Handbook of Statistics on the Indian Economy for FY23.

Of the total e-rupee circulation, **Rs.10.69 crore is wholesale CBDC** whereas **Rs.5.70 crore** is retail CBDC, data showed.

The circulation is highest for Rs.500 CBDC notes at Rs.2.71 crore, followed by Rs.200 notes at 1.16 percent. Circulation for all other currency denominations of 50 paise to Rs.100 was below 1 percent, ranging between 0.01-0.83 percent.

E-rupee is the digital representation of India's legal tender and similar to physical currency, is issued in various denominations to banks.

Note: RBI had introduced the CBDC pilot for the wholesale segment, known as the CBDC (W) or e₹-W, in November 2022 and the retail pilot known as CBDC (R) or e₹-R in December 2022.

54. Indian Bank (IB) has launched the '**IB SAATHI**' initiative to provide an integrated ecosystem for all stakeholders in the financial sector through the business correspondent (BC) route.

The **IB Sustainable Access and Aligning Technology for Holistic Inclusion (SAATHI)** offers an enhanced user experience through the simplified delivery of services, encompassing both basic and value-added offerings to customers.

55. Ujjivan Small Finance Bank (Ujjivan SFB), a leading small finance bank, has introduced the





Maxima Savings Account and **Business Maxima Current Account** for the premium customer segment. Both the accounts offer a RuPay Select Debit Card.

Features of Maxima Savings Account:

- Annual interest rate: **7.5%**
- Customers can open the account with Rs.1 lakh.
- Customers also have the flexibility to maintain Rs.15 lakh or more in fixed deposits to meet the balance eligibility criteria.
- A Complimentary Health Prime Benefit is also offered.
- Other benefits: higher transaction limits, free cheque & DD Issuances, free transactions across all channels, and unlimited cash deposits and withdrawals at any branch.

Features of Business Maxima Current Account:

- It features convenient online banking, instant fund transfers, and cash management options.
- It offers a daily ATM withdrawal limit of Rs.5 lakhs per day.
- It provides provision for customizing cash deposit limits for businesses.

56. Meta has launched **UPI (Unified Payments Interface)** payments for **WhatsApp Business** messaging in India. This allows customers to pay businesses on the app with the UPI option of their choice.

The accepted payment methods now include Pay on WhatsApp, credit/debit cards, net banking, Google Pay, PhonePe, Paytm, and more UPI options.

The initial payment partners are **RazorPay and PayU**.

57. The Small Industries Development Bank of India (SIDBI) has inked an agreement with the **Digital Lenders Association of India (DLAI)** to boost the country's fintech sector.

The agreement aims to develop standard protocols to expedite the adoption of digital lending partnerships including alliances between banks and Lending Service Providers (LSPs).

58. The Securities and Exchange Board of India (SEBI) has recently (**Sep'23**) approved the proposal to provide flexibility to large corporates (LCs) in raising funds through issuance of debt securities for incremental financing needs.

The measures are:

- SEBI Board has approved to remove penalty on LCs which are not able to raise a certain

percentage of incremental borrowing from the debt market.

- Higher monetary threshold for defining Large Corporates (LCs).
- LCs are mandated to raise a minimum of 25 percent of their incremental borrowings over a contiguous block of three years through corporate bonds.
- Introduce a system of incentives and balanced disincentives.
- Removing the need for LCs to file identification and compliance statements.

Other key decisions:

The SEBI board has also approved streamlining the framework for credit of unclaimed amounts of investors in listed entities. This will be applicable for listed entities other than companies, **Real Estate Investment Trusts (REITs) and Infrastructure Investment Trusts (InvITs)**.

- The SEBI board has also extended timeline for compliance with enhanced qualification and experience requirements for Investment Advisers till September 30, 2025.

59. The Uttar Pradesh New and Renewable Energy Development Agency (UPNEDA) has signed two **Memorandum of Understanding (MoUs)** with **Small Industries Development Bank of India (SIDBI)** to make direct financing options available for micro, small, and medium enterprises (MSMEs).

Of these MoUs, the first one is a structured arrangement for solarisation of residential units at **Ayodhya**, while the second one is for bio-energy and renewable project financing.

Notably, the state government of Uttar Pradesh has nominated Ayodhya to be developed as a Solar city.

60. Axis Bank has launched '**NEO for Business**', a distinctive Transaction Banking platform specially curated for Indian Micro, Small, and Medium Enterprises (MSMEs). This is a first-of its-kind comprehensive digital proposition that caters to the real, current, and emerging Transaction Banking needs of MSMEs.

It has contemporary **UX (User Experience)/UI (User Interface)** along with bank-grade security features. '**NEO for Business**' is the latest launch as part of '**NEO by Axis Bank**' branding.





61. Utkarsh Small Finance Bank has launched **Interoperable Cardless Cash Withdrawal (ICCW)** service with an aim to allow Unified Payments Interface (UPI) enabled cardless cash withdrawal from Utkarsh Small Finance Bank Automated Teller Machine (ATM).

ICCW enables withdrawal through Quick Response (QR) code.

Initially, customers can enjoy up to two ICCW transactions per day per account, with a withdrawal limit of Rs. 10,000/- per transaction.

62. The University of Wollongong (UOW) Australia, in collaboration with the **NSE Academy**, has launched their new book titled **“Introduction to Corporate Finance (sixth edition)”** at the **National Stock Exchange (NSE)** in Mumbai, Maharashtra.

The book is authored by lecturers at UOW campuses in Hong Kong and Dubai.

The book includes a chapter which details how shares are traded on the national stock exchange.

63. Kamats Restaurants has tied up with **IDFC First Bank** for easy registration and recharge of **FASTag** at its outlets along the highways in Maharashtra and Gujarat.

Under this tie up, users can now register for a fresh FASTag or recharge their existing FASTag accounts at Kamats outlets.

64. PhonePe has introduced the **Indus Appstore Developer Platform** and invited all Android app developers to register and upload their apps using the self-serve developer platform **"www.indusappstore.com."**

- The app listings on the Indus Appstore Developer Platform will be free for the first year, following which a nominal annual fee will apply.

- The Indus Appstore will not charge developers any platform fee or commission for in-app payments.
- The Appstore will also have a 'Launch Pad' for new developers to onboard their apps and provide them with better visibility and search optimisation.

65. HDFC Securities has launched a new app called **HDFC SKY** to compete with discount brokerages in India. The app is designed to support investors and traders of all experience levels to participate seamlessly in the financial markets and achieve their financial goals.

HDFC SKY has a one-price slab of **Rs.20** for both intraday and delivery across segments, MTF at 12 percent, coupled with zero account opening and maintenance charges for the first year.

HDFC Sky, like several trading apps, is open to all investors and traders.

66. IndusInd Bank has entered into a multi-year association with the **International Cricket Council (ICC)** as a Global Partner for the ICC Men's Cricket World Cup 2023 and future ICC men's events.

The partnership aims to drive exciting activities for IndusInd Bank's customers, employees and cricket fans.

The premium opportunity will come through ownership of the flagship Anthem Companion programme.

In this programme, selected customers of IndusInd Bank and their employees will have the opportunity for their children to participate in teams walking out onto the field before the start of play for the national anthems.

WINNER INSTITUTE
India's Best Banking Institute

SBI	SBI PO SBI SO SBI CLERK	TOTAL 12,000 Vacancies	RBI	Gr. B Officer Assistant Attendant	15,000 Vacancies
NATIONALISED BANKS	IBPS PO/CLERK IBPS - RRB PO/CLERK	TOTAL 23,000 Vacancies	LIC	LIC ADO LIC AAO	8,500 Vacancies
STAFF SELECTION COMMISSION	SSC CGL / CHSL / MTS	19,857 Vacancies	RAILWAY RECRUITMENT BOARD	RRB NTPC	1,10,000 Vacancies

DO YOU WANT TO BE THE BANK OFFICER?





National Affairs

Government to celebrate sixth Rashtriya Poshan Maah 2023 in September

- The Central Government is celebrating the **sixth Rashtriya Poshan Maah** in September 2023.
- **Objective:** To comprehensively tackle malnutrition through a life-cycle approach and to cultivate widespread awareness concerning critical human life stages comprising pregnancy and adolescence.
- **Aim:** To foster nutritional understanding across India through a theme centered on "Suposhit Bharat, Sakshar Bharat, Sashakt Bharat" (Nutrition-rich India, Educated India, Empowered India).

President launch the theme "The Year of Positive Change" of Brahma Kumaris

- The **President Droupadi Murmu** graced the state-level launch of the theme of the year "The Year of Positive Change" of Brahma Kumaris at Raipur, Chhattisgarh.
- **Brahma Kumaris** are working tirelessly to spread love, harmony, and peace in the world.
- She urged all to develop their inner strength, keep doing positive work, and stay with positive thoughts and good company.
- She advised me to be in the company of such people who inspire me to follow the right path.

India, USA join hands to launch RETAP for c

- **India** and the **United States** launched the **Renewable Energy Technology Action Platform (RETAP)** under the umbrella of the **Strategic Clean Energy Partnership**.
- **Objective:** To revolve around the development of green and clean hydrogen, wind energy, and long-duration energy storage solutions.
- **Aim:** To explore opportunities in geothermal energy, ocean/tidal energy, and other mutually identified emerging technologies, opening doors for diverse renewable energy avenues.

Nagaland becomes first state to launch Aadhaar linked birth registration

- **Nagaland** became the first state in the northeastern region to initiate **Aadhaar-linked birth registration (ALBR)**.
- **Objective:** To enable children's access to various social welfare schemes designed for their welfare.

- **Aim:** To streamline birth registration by integrating it with Aadhaar enrolment for children in the age group of 0 to 5

ISRO launched India's first solar mission Aditya-L1 successfully

- The **Indian Space Research Organisation (ISRO)** has successfully launched **India's first solar observatory mission** named **Aditya L1** from **Sathish Dhawan Space Centre Sriharikota**.
- It was launched from the **PSLV C57 rocket**.
- In Aditya L1, L1 refers to **Lagrange Point 1**.
- **Aim:** To study the Solar upper atmospheric (chromosphere and corona) dynamics
- As per the reports, it will take **125 days** (approx. 4 months) to reach designated point **L1** to **study the Sun's mysteries**.

Govt forms high-level committee to examine One nation, One election

- The **Government of India** has constituted an **eight-member high-level committee to examine One Nation, One Election**.
- **Former President Ram Nath Kovind** has been appointed as **Chairman of the committee**.
- **Other members:** HM Amit Shah, Congress MP Adhir Ranjan Chowdhury, Former Rajya Sabha member Ghulam Nabi Azad, Former Chairman 15th Finance Commission N.K. Singh and others
- **Law and Justice Minister Arjun Ram Meghwal** will attend the meetings of the committee as special invitee.

Aviation Minister Jyotiraditya Scindia inaugurates Utkela Airport in Odisha

- **Civil Aviation Minister Jyotiraditya Scindia** has inaugurated **Utkela Airport in Odisha**.
- It has been developed as a **regional airport** under the **UDAN scheme** of the **Ministry of Civil Aviation**, Government of India at a **cost of Rs 31.07 crore**.
- It has a runway of **length 917 metre** (2,995 ft) with a **width of 30 metre**.
- With the addition of Utkela Airport, **Odisha will now have five airports**.
- **IndiaOne**, will be running the flights on this route from **31 August onwards**.





CCI approves merger of Tata SIA Airlines into Air India

- The **Competition Commission of India (CCI)** approved the **merger of Tata Group airlines Vistara and Air India**.
- This will make Air India, India's leading domestic and international carrier with a combined fleet of 218 aircraft, making it India's largest international carrier and second largest domestic carrier.
- The **deal is part of Tata Sons chairman N Chandrasekaran's effort to simplify the conglomerate's businesses** and make them more efficient.
- The **Competition Commission of India (CCI)** is the **chief national competition regulator in India**. It was established in **2003 in New Delhi**. It is a **statutory body within the Ministry of Corporate Affairs** and is responsible for enforcing the Competition Act, 2002 to promote competition and prevent activities that have an appreciable adverse effect on competition in India. The CCI looks into cases and investigates them if the same has a negative impact on competition.

Koraput Kalajeera Rice Gets GI Tag

- **Odisha's 'Koraput Kalajeera Rice'**, which is famous for its **unique aroma and nutritional value**, was granted the **Geographical Indications (GI) status**.
- It is also called the **'Prince of Rice'**. This highly aromatic rice looks like coriander seeds.
- It is believed that the **medicinal quality of this rice enhances memory, controls diabetes, increases hemoglobin levels and the body's metabolism**.

Country's first solar city to be inaugurated in Sanchi of Madhya Pradesh

- **Chief Minister Shivraj Singh Chouhan** inaugurated the **country's first solar city Sanchi in Madhya Pradesh**.
- **Aim:** To reduce Annually about 13 thousand 747 tonnes of carbon dioxide emissions in Sanchi Solar City
- An effort has also been made to attract tourism by reducing environmental pollution through eco-friendly facilities in Sanchi.
- Battery operated e-rickshaws and garbage vehicles will also run in the city. E-vehicle charging stations have also been installed.

World's tallest Nataraja statue installed at G20 summit venue

- The **world's tallest Nataraja statue** has been installed at **Bharat Mandapam, the venue of the G20 summit in Delhi**.
- The **28-foot-tall statue weighing 20 tonnes** was made in a record time of **seven months** by **sculptor Radhakrishnan Sthapathy** and his team at **Swamimalai in Thanjavur District of Tamil Nadu**.
- The statue was **built in Ashtadhatu (8 metals)** using the **traditional casting method**.
- The **statue was transported to the New Delhi in four days**.

Jharkhand Cabinet approves 1k pension for transgender community

- **Jharkhand Cabinet** gave its approval for **transgender persons** to be provided **benefits of the State Social Security Scheme** under which they will be given a **pension of Rs 1,000 per month**.
- **Transgenders** are included in the **category of OBC**.
- **Proposals are first, transgender persons should be declared as a third gender**
- **Second, those transgender persons who are not covered under any other category for reservation should be included in the OBC at serial number 46 in the list**

PM Modi launches global biofuels alliance at G20 summit in New Delhi

- India launched the **Global Biofuel Alliance** at a **G20 summit in New Delhi**.
- The **Global Biofuel Alliance** is an **India-led Initiative** to **develop an alliance of Governments, International organizations, and Industry** to facilitate the adoption of biofuels.
- **Aim:** To position biofuels as a key to energy transition and contribute to jobs and economic growth.
- The Alliance which will help strengthen India's position globally and will focus on collaboration.

Goa Governor Launches 'Mashaal' For 37th National Games

- **Goa Governor P.S. Sreedharan Pillai** launched **'Mashaal'** for **37th National Games 2023** at a **program held in Durbar Hall Raj Bhavan, Donapaula**.





- The **37th National Games** will be held in **Goa** from **October 25 to November 9 2023**
- The **Governor** also released **anthem** (theme song) of **national games** for which **actor Amitabh Bachchan** has given his voice
- He highlighted the nationwide participation expected for this prestigious event and the potential positive impact on Goa's tourism sector

Indore ranked first in Swachh Vayu Sarvekshan 2023

- **Indore** secured the **first rank** followed by **Agra** and **Thane** in the **cleanest air in India** according to the **Swachh Vayu Sarvekshan 2023 (Clean Air Survey)** report released in **Bhopal** by **Union Environment Minister Bhupender Yadav**.
- **Bhopal** stood **fifth** while **Delhi** took the **ninth** spot.
- Prime Minister Narendra Modi had announced the intent and plan to improve the air quality in more than 100 cities through a holistic approach.

Transnational grid interconnections for "One Sun, One World, One Grid"

- At the **18th G20 Summit**, a one-day conference themed "**Transnational Grid Interconnections for One Sun, One World, One Grid (OSOWOG)**" convened in **New Delhi**
- **Aim:** To enable nations to harness the abundant energy resources of the sun, particularly as the world transitions toward renewable energy sources.
- It makes round-the-clock renewable energy more cost-effective, reducing the need for energy reserves and ultimately lowering electricity costs for the populace

India-Middle East-Europe' economic corridor, a modern-day spice route

- PM **Narendra Modi** announced the **project** during the **annual Group of 20 summit** of the **world's top economies** to launch the **India-Middle East-Europe economic corridor** including **shipping** and **railway links**.
- **Aim:** To **boost trade**, **transport energy resources** and **improve digital connectivity**.
- The **first-of-its-kind economic corridor** will be an initiative on cooperation on **connectivity** and **infrastructure** involving **India, UAE, Saudi Arabia, EU, France, Italy, Germany, and the US**

India hands over G20 Presidency to Brazil

- The **18th G20 Summit** successfully concluded in **New Delhi** with **India handing over the Presidency to Brazil**.
- After receiving the **gavel**, **President of Brazil Luiz Inacio Lula Da Silva** appreciated **India's efforts** in **leading the G20 presidency** saying that India gave the voice to issues of interest to emerging countries.
- Prime Minister Modi raised the issue of reforms in the **United Nations Security Council** by emphasizing on a new global structure

3-member team to explore depths of the ocean in first manned ocean mission

- **Minister of Earth Sciences Kiren Rijiju** announced the **Samudrayaan Mission (MATSYA 6000)** **India's first manned** mission to **explore the deep ocean**, where **three people** will be sent into the **depth of 6,000 metre** in a **submersible**.
- **Aim:** To sustainably use marine resources for the country's economic growth and livelihood along with creating job and maintaining the health of the marine ecosystem
- It is designed to study the deep ocean resources and conduct biodiversity assessment

Vijayawada gets IGBC's 'Green Railway Station' certification

- **Vijayawada Railway Station** was awarded the **'Green Railway Station'** certification with the highest rating of **Platinum** by the **Indian Green Building Council (IGBC)**
- Award is given for its efforts in improving environmental standards and providing eco-friendly services to passengers.
- This is an upgrade of the station's ratings, from **gold** in 2019 to **platinum** in 2023.
- It bagged second in the South-Central Railway zone after Secunderabad to have bagged the **platinum** rating.

MP cabinet approves Mob Lynching Victim Compensation Scheme 2023

- **Madhya Pradesh government** will provide **Rs 10 lakh** as compensation to the kin of any person killed in a mob lynching incident.
- **There will be a provision of compensation of Rs 4 to Rs 6 lakh for the injured.**
- This will also include all those incidents of mob lynching that occur due to religion, caste, language, or any other reason.





- Under the scheme, mob lynching will be considered in which five or more accused are involved.

VP Jagdeep Dhankhar inaugurated International Conference on dam safety

- VP Jagdeep Dhankhar inaugurated the International Conference on Dam Safety at Jaipur in Rajasthan.
- According to the Jal Shakti Ministry, there are over **6000 dams** in India and it is ranked third globally in terms of large dams.
- **Aim:** To provide a major platform for experts to come together and debate cutting-edge topics in dam safety and management.

Assam Governor launches 'Sarpanch Samvad' app

- Assam Governor Gulab Chand Kataria unveiled 'Sarpanch Samvaad', a mobile application app of the Quality Council of India (QCI) in Raj Bhavan.
- **Aim:** To connect approximately 2.5 lakh Sarpanchs across India, which serves as a holistic platform for networking, knowledge dissemination, and collaboration.
- Through this initiative, Sarpanchs can spotlight developmental activities in their villages, learn about best practices, and foster connections nationwide.

14th edition of World Spice Congress (WSC) held in Mumbai

- The 14th edition of the World Spice Congress (WSC) began at Vashi in Navi Mumbai.
- **Theme:** 'VISION 2030: S-P-I-C-E-S'
- The **three-day event** has been organized by the Spices Board India, Ministry of Commerce and Industry, in association with various trade bodies and export forums.
- The event has the presence of policymakers, regulatory authorities, spice trade associations, government officials as well as technical experts from G20 countries, among others.

Cabinet approves eCourts phase III for 4 years

- The Indian government has given the green light to Phase III of the e-Courts project, marking another significant step towards modernizing the country's judicial system.
- With a substantial budget allocation of **Rs 7,210 crore**, this initiative aims to leverage technology to enhance the efficiency and accessibility of the courts.

- One of the central objectives of the e-Courts Phase III project is to transition towards a digital, online, and paperless court system.

Ministry of Railways launches 'Swachhata Pakhwada-2023'

- The Ministry of Railways in India has officially launched the Swachhata Pakhwada 2023 campaign.
- This initiative, aimed at promoting cleanliness and environmental consciousness, commenced on the 15th of September, 2023.
- Chairperson & CEO of the Railway Board, Jaya Varma Sinha, kicked off the event at Rail Bhawan by leading the Swachhata Pledge.
- The Swachhata Pledge embraced by the entire Railway family is built upon three fundamental principles

Dharmendra Pradhan, Om Birla launch 'Skills on Wheels' initiative

- Union Minister for Education Dharmendra Pradhan with Lok Sabha speaker Om Birla launched the 'Skills on Wheels' initiative with NSDC and IndusInd Bank.
- **Aim:** To generate awareness around the government's skill development mission, opportunities and support system available for youths.
- **Objective:** To promote digital literacy and digital skills in which India is developing global competency this scheme with the help of NSDC has been launched.

UNESCO World Heritage Sites in India Till Sep 2023

- A World Heritage Site is a place that is listed by UNESCO for its special cultural or physical significance. The list of World Heritage Sites is maintained by the international 'World Heritage Programme', administered by the UNESCO World Heritage Committee.
- The UNESCO World Heritage Committee is composed of 21 UNESCO member states, elected by the General Assembly.
- The United Nations Educational, Scientific and Cultural Organization (UNESCO) seeks to encourage the identification, protection, and preservation of cultural and natural heritage around the world considered to be of outstanding value to humanity.





- This is embodied in an **international treaty called the Convention concerning the Protection of the World Cultural and Natural Heritage, adopted by UNESCO in 1972.**
- As of **Sep 2023, India** has **42 world heritage sites** that include **34 Cultural properties, 7 Natural properties,** and **1 mixed site.**

United Nations Educational, Scientific and Cultural Organization

- It was founded in **1945** to develop the **“intellectual and moral solidarity of mankind”** as a means of **building lasting peace.**
- It is located in **Paris, France.**

Sacred Ensembles of the Hoysalas

- The **Sacred Ensembles of the Hoysalas** is a group of **three Hoysala-style temples in South India.**
- The **temples are located in Belur, Halebidu and Somanathapura** in the **Hassan and Mysuru districts of Karnataka.**
- The temples, often described as **‘poetry carved in stone’** were recommended to the list by **India’s Culture Ministry in 2022-23.**
- **The temples included in the ensemble are:**
 - Channakeshava Temple, Belur, Hassan district (Commissioned by King Vishnuvardhana, dedicated to God Vishnu)

- Hoysalesvara Temple, Halebidu, Hassan district (Commissioned by King Vishnuvardhana, dedicated to God Shiva)
- Kesava Temple, Somanathapura, Mysuru district (Consecrated by Somanatha Dandanayaka, a general of the Hoysala King Narasimha III, dedicated to God Vishnu)
- The temples were built by the **followers of Vaishnavism, Shaivism, and Jainism,** and they are richly decorated with stone sculptures and carvings.

Santiniketan

- Located in West **Bengal’s Birbhum** district, **Santiniketan,** meaning **“abode of peace,”** began its development in 1901 and is where Rabindranath Tagore laid the foundation for Visva-Bharati University.
- It was established by Rabindranath Tagore.
- Santiniketan has immense significance in human values, architectural and technological developments, monumental arts, town planning, and landscape design.
- Efforts to get Santiniketan listed as a UNESCO World Heritage Site date back to 2010, with the latest nomination proposal initiated in the 2020-21 fiscal year.
- The Archaeological Survey of India (ASI) has been involved in restoring various structures in Santiniketan in recent years.

List of UNESCO World Heritage Sites in India

Natural World Heritage sites in India

Natural World Heritage Site	State	Year of Notification
Kaziranga National Park	Assam	1985
Keoladeo Ghana National Park	Rajasthan	1985
Manas Wildlife Sanctuary	Assam	1985
Nanda Devi National Park and Valley of Flowers	Uttarakhand	1988
Sundarbans National Park	West Bengal	1987
Western Ghats	Maharashtra, Goa, Karnataka, Tamil Nadu and, Kerala	2012
Great Himalayan National Park	Himachal Pradesh	2014





Cultural World Heritage Site

Cultural World Heritage Site	State	Year of Notification
Sacred Ensembles of the Hoysalas	Karnataka	2023
Santiniketan	West Bengal	2023
Kakatiya Rudreshwara (Ramappa) Temple	Telangana	2021
Dholavira: a Harappan City	Gujarat	2021
The Architectural Work of Le Corbusier, an Outstanding Contribution to the Modern Movement	Chandigarh	2016
Victorian and Art Deco Ensemble of Mumbai	Maharashtra	2018
Historic City of Ahmedabad	Gujarat	2017
Jaipur City	Rajasthan	2020
Archaeological Site of Nalanda Mahavihara (Nalanda University)	Bihar	2016
Rani-Ki-Vav	Gujarat	2014
Hill Forts of Rajasthan	Rajasthan	2013
The Jantar Mantar	Rajasthan	2010
Red Fort Complex	Delhi	2007
Champaner-Pavagadh Archaeological Park	Gujarat	2004
Chhatrapati Shivaji Terminus	Maharashtra	2004
Rock Shelters of Bhimbetka	Madhya Pradesh	2003
Mahabodhi Temple Complex at Bodh Gaya	Bihar	2002
Mountain Railways of India	Tamil Nadu	1999
Humayun's Tomb, Delhi	Delhi	1993
Qutb Minar and its Monuments, Delhi	Delhi	1993
Buddhist Monuments at Sanchi	Madhya Pradesh	1989
Elephanta Caves	Maharashtra	1987
Great Living Chola Temples	Tamil Nadu	1987
Group of Monuments at Pattadakal	Karnataka	1987





Churches and Convents of Goa	Goa	1986
Fatehpur Sikri	Uttar Pradesh	1986
Group of Monuments at Hampi	Karnataka	1986
Khajuraho Group of Monuments	Madhya Pradesh	1986
Group of Monuments at Mahabalipuram	Tamil Nadu	1984
Sun Temple, Konarak	Orissa	1984
Agra Fort	Uttar Pradesh	1983
Ajanta Caves	Maharashtra	1983
Ellora Caves	Maharashtra	1983
Taj Mahal	Uttar Pradesh	1983

Mixed World Heritage Sites

Mixed World Heritage Site
Khangchendzonga National Park





India Ranked 52nd in Digital Quality of Life Index

- India has been ranked 52nd out of 121 countries in the Digital Quality of Life Index Survey 2023.
- The survey has been carried out by cybersecurity firm Surfshark.
- The annual survey by the Netherlands-based firm has ranked 121 countries on five factors: internet quality, internet affordability, e-infrastructure, e-government, and e-security.
- In Asia, India takes 13th place, with Singapore the leader in the region.
- The top 3 Countries in the Digital Quality of Life Index survey are Denmark, South Korea, and Finland

Centre launches three game-changing initiatives for farmers

- Centre launched a series of transformative initiatives, aimed at revolutionizing agriculture in the country.
- It includes Kisan Rin Portal, Door to Door KCC Campaign, and Weather Information Network Data Systems (WINDS) Manual.
- **Aim:** To amplify financial inclusion, streamline data utilization, harness technology, and enhance the livelihoods of the farmer.
- **Objective:** To help in furthering the goal of agricultural transformation and sustainable economic growth for farmer.
- The Kisan Rin Portal (KRP), developed in collaboration with multiple government departments, is poised to revolutionize access to credit services under the Kisan Credit Card (KCC). This digital platform offers a comprehensive view of farmer data, loan disbursement specifics, interest subvention claims, and efficient agriculture credit.
- The Ghar Ghar Kisan Credit Card (KCC) Abhiyaan is an ambitious campaign to extend the benefits of the Kisan Credit Card (KCC) Scheme to every farmer across India. This campaign aims to achieve universal financial inclusion, ensuring that every farmer has unhindered access to credit facilities. The Ministry said total number of operative KCC accounts as of March 2023 is 7.35 Crores with total sanctioned limit of 8.85 lakh crores rupees.
- The Weather Information Network Data Systems (WINDS) initiative is an instrumental innovation, that leverages advanced weather data

analytics to provide stakeholders with actionable insights on weather.

Rashtriya Vigyan Puraskar

- On the lines of civilian awards, Government of India will now recognise scientists with Rashtriya Vigyan Puraskar
- It has 4 categories, Vigyan Ratna, Vigyan Shri, Vigyan Yuva-Shanti Swarup Bhatnagar, and Vigyan Team.
- Vigyan Ratna will recognise the lifetime achievement of scientist.
- Vigyan Shri will recognise distinguished contributions to a field
- Vigyan Yuva Shanti Swarup Bhatnagar will encourage young scientists who have made exceptional contributions in their field.
- Vigyan Team will recognise teams of three or more.
- The awards will commence in 2024.
- The Rashtriya Vigyan Puraskar will be awarded in 13 domains – Physics, Chemistry, Biological Sciences, Mathematics and Computer Science, Earth Science, Medicine, Engineering Sciences, Agricultural Science, Environmental Science, Technology and Innovation, Atomic Energy, Space Science and Technology.
- There will only be three Vigyan Ratnas awarded yearly: 25 Vigyan Shri, 25 Vigyan Yuva, and 3 Vigyan Team.
- Only Vigyan Yuva will have an age limit of 45 years.

Assam govt to launch scheme to give Rs 2 lakh each to two lakh youth

- Assam Chief Minister Himanta Biswa Sarma has unveiled a transformative scheme called 'Mukhya Mantri Atmanirbhar Asom aimed at bolstering the self-reliance of the state's youth.
- **Objective:** To foster self-sufficiency and entrepreneurship among the youth of Assam.
- Under this initiative, a generous financial aid of Rs. 2 lakh will be provided to each eligible young person, empowering them to pursue self-employment opportunities and chart their own path to success.

Rajasthan tops the list in solar water pump installations

- Rajasthan tops the list in solar water pump installations in 2023.





- **More than 62,000 farmers** have directly benefited from the scheme introduced by the Ashok Gehlot government four-and-a-half years ago.
- **According to the gov, farmers in Rajasthan are encouraged to install solar pumps for irrigation**, instead of relying on electricity connections and diesel-powered plants.
- The state government is encouraging farmers by offering 60 percent subsidy for installing solar pumps

Northeast's mithun gets 'food animal' tag and its meat a leg-up

- **The Food Safety and Standards Authority of India (FSSAI)** has recently recognized the Mithun as a 'food animal,' opening doors for its commercial use found in Arunachal Pradesh.
- **Aim:** To promote its meat as a commercial product can indeed have significant economic and cultural implications for the region.
- It is a captivating and culturally significant bovine species found in Northeast India.
- Its role in the livelihoods of indigenous communities, ecological balance.

Oil minister launched India's first green hydrogen fuel cell bus in Delhi

- **Union Minister of Petroleum and Natural Gas Hardeep Singh Puri** flagged off India's first green hydrogen fuel cell bus in Delhi
- The success of this project can catapult India from being a net importer of fossil energy to becoming a net exporter of clean hydrogen energy.

Biswanath Ghat in Assam named 'Best Tourism Village of India 2023

- **Assam Chief Minister Himanta Biswa Sarma** announced that Biswanath Ghat has been

selected as the Best Tourism Village of India 2023 by the Ministry of Tourism.

- Located on the banks of the **Brahmaputra River**, **Biswanath Ghat** is also popularly known as 'Gupta Kashi' and is named after the ancient Biswanath Mandir.
- The village is located towards the south of Biswanath Chariali Town.
- The ghat boasts a cluster of temples of different gods.

Madhya Pradesh notifies 'Veerangana Durgavati Tiger Reserve'

- **Madhya Pradesh**, which is home to the most tigers in the country, has got a new protected area for the big cats named '**Veerangana Durgavati Tiger Reserve**', the **seventh** in the state and **54th** in the **country**.
- **Veerangana Durgavati Sanctuary**, recognized for their ecological significance in preserving biodiversity, including flora, fauna, geology, and zoology
- Until now, M.P. was home to six tiger reserves – Kanha, Bandhavgarh, Satpura, Pench, Panna and Sanjay-Dubri.

PM Modi launches Sankalp Saptah in 500 Aspirational Blocks

- **Prime Minister Narendra Modi** has launched a unique week-long programme for aspirational blocks in the country called '**Sankalp Saptah**' at the Bharat Mandapam on 30 September 2023.
- It is being implemented in **500 aspirational blocks** across **329 districts** in the **country**.
- '**Sankalp Saptah**' is linked to the effective implementation of the **Aspirational Blocks Programme (ABP)**.
- The ABPP was **launched** across the nation by the **Prime Minister** on 7 January, 2023.





International Affairs

Battle of Haifa

- For over nine decades, the Battle of Haifa and the contributions of Indian soldiers were largely forgotten, confined to the corners of history books and archives. It wasn't until 2010 that Haifa Day was officially commemorated, largely due to limited awareness about this historical event.
- The victory at Haifa was a significant achievement during World War I. After the war, the contributions of Indian soldiers were gradually forgotten. However, in 1953, the 61st Cavalry regiment was established to commemorate Haifa Day, keeping the memory of this battle alive. In 2010, Haifa Day was officially commemorated, thanks to Brig. M S Jodha's research and efforts.

Five Eyes Alliance

- This intelligence-sharing alliance comprising the United States, United Kingdom, Australia, Canada, and New Zealand
- The Five Eyes Alliance traces its origins to World War II when the UK and the US decided to share intelligence after successfully breaking German and Japanese codes. The initial Britain-USA (BRUSA) agreement was established between the US War Department and the UK's intelligence and security agency, Government Code and Cypher School (GC&CS). This agreement aimed to share intelligence information, support US forces in Europe, exchange personnel, and develop joint regulations for handling sensitive material.
- The BRUSA agreement laid the groundwork for the UK-USA (UKUSA) agreement, officially signed in 1946. Canada joined the alliance in 1949, followed by New Zealand and Australia in 1956, forming the Five Eyes. While the existence of the agreement was known from the 1980s, it wasn't officially acknowledged until the release of the UKUSA agreement files in 2010.

India-UN Capacity Building Initiative

- India and the United Nations have joined forces to initiate a collaborative capacity-building effort aimed at operationalizing development-focused objectives from India's G20 Presidency. This initiative seeks to share India's best practices with partner countries in

the Global South. Announced during the event 'India-UN for the Global South-Delivering for Development,' the initiative reinforces India's commitment to South-South cooperation and the pursuit of Sustainable Development Goals (SDGs).

- This initiative will significantly contribute to global efforts aimed at achieving the SDGs by strengthening South-South Cooperation.

Universal Health Coverage (UHC)

- A joint report by the World Health Organization (WHO) and the World Bank delivers sobering news: progress towards achieving Universal Health Coverage (UHC) has stalled since 2015. The report also shines a light on the worsening financial protection for individuals seeking health services.
- Joint WHO and World Bank report serves as a wake-up call. It highlights the urgent need to revitalize efforts to achieve Universal Health Coverage, a goal vital for improving global health, reducing poverty, and ensuring that no one faces financial ruin when seeking essential healthcare services.
- The world is falling short of WHO's ambitious

Samudra Prahari's

- On September 20, 2023, the Indian Coast Guard's Pollution-Control Vessel 'Samudra Prahari' showcased its maritime proficiency during a comprehensive Pollution Response Table-Top exercise and demonstration at Khlong Toei Port in Bangkok, Thailand. This marked the culmination of the vessel's four-day visit to Thailand, which aimed to foster cooperation, address shared challenges, and promote environmental responsibility.
- The Pollution Response Table-Top exercise was the highlight of 'Samudra Prahari's' visit. It sought to tackle maritime pollution challenges and test Thailand's Maritime Pollution Response contingency plan in collaboration with the Indian Coast Guard. The exercise not only demonstrated India's commitment to regional cooperation but also facilitated knowledge sharing among personnel from various Thai government 61 per cent Women Parliamentarians.





- **Rwanda stands out globally with an impressive 61 percent of women in its Parliament**, a stark contrast to many other countries. This extraordinary representation of women in Rwanda's political sphere can be traced back to the country's tumultuous history.
- The **ethnic tensions between Hutus and Tutsis fueled by colonial rule led to decades of conflict, culminating in the tragic Rwandan genocide in 1994**. The aftermath left a predominantly female population due to the large number of men killed during the violence

Japan's Population

- **Japan's demographic crisis deepens as more than 10% of the country's population is now aged 80 or older**, according to data released by the **Ministry of Internal Affairs and Communications**. This concerning milestone comes alongside a **record-high proportion of elderly citizens**, defined as those **aged 65 and above**, making up **29.1% of the population** – the highest rate globally. Despite several government efforts, **Japan's demographic issues persist, with Prime Minister Fumio Kishida emphasizing the urgency of child-rearing support to maintain social functions**.
- **Japan confronts a declining population**, with a fertility rate of 1.3, far below the 2.1 needed for stability.

Critical Raw Materials Act

- The **European Parliament has approved the Critical Raw Materials Act** with a significant majority, aiming to **reduce the European Union's dependence on China for critical minerals and metals essential for green technologies**. The EU seeks to **increase its domestic capacity** for these materials used in manufacturing solar panels, windmills, and electric car batteries. The **regulation aims to diversify imports and ensure secure and sustainable supplies by 2030**.
- The EU also aims to **increase its processing capacity and prioritize strategic partnerships with countries like Australia and Chile to diversify the supply chain**. However, environmentalists have expressed concerns about permitting processes without addressing environmental standards. The law will undergo further discussions between the Council and Parliament for finalization

London's India Club

- **London's iconic India Club, which has served as a cultural and culinary hub for the Indian community in the UK, was permanently closed on September 7, 2023**. The club has been a venue for discussions, social gatherings, and authentic Indian cuisine. It has also **hosted prominent figures** such as **India's first President, Dr. Rajendra Prasad, and Lord Mountbatten**. The club faced threats of demolition and rent increases in recent years, and the financial impact of the COVID-19 pandemic made its operations unsustainable. Efforts to save the club, including a public appeal, were unsuccessful

Global Debt

- The **International Monetary Fund (IMF) reported that global debt as a share of economic output decreased for the second consecutive year in 2022**, but this trend may be ending as the post-COVID growth surge wanes. **According to the IMF's Global Debt Database update, the world's total debt-to-GDP ratio fell to 238% in 2022, down from 248% in 2021 and 258% in 2020**. However, despite the decline over the past two years, global debt remains well above the 2019 level of 238% of GDP.
- **China has been a major contributor to the increase in global debt in recent years, with its debt burden growing to 272% of GDP in 2022**.
- The **United States** also saw a decline in its total debt-to-GDP ratio, from **284% in 2021 to 274% in 2022**.

Global Partnership for Financial Inclusion (GPFI) Meeting

- The **Fourth G20 Global Partnership for Financial Inclusion (GPFI) Meeting** is scheduled to be held in **Mumbai from September 14 to 16, 2023**. **Delegates from more than 50 G20 member countries, special invitees, and international organizations will gather to discuss the ongoing financial inclusion agenda under the G20 India Presidency, with a particular focus on Digital Financial Inclusion and SME Finance**.
- A **Symposium on "Advancing Financial Inclusion through Digital Public Infrastructure"** will be held on **September 16, 2023**, with a particular focus on consumer empowerment through digital and financial literacy, as well as consumer protection





India-Saudi Investment Forum 2023

- An **India-Saudi Arabia Investment Forum 2023** was organized in **New Delhi** during the state visit of **Saudi Arabia's Crown Prince**. This marked a significant milestone as the **first formal investment symposium between the two nations**. **Over 500 companies from both countries participated** in the event, reflecting the strong commitment to economic cooperation. The **Saudi Crown Prince** had previously **announced an investment of approximately \$100 billion** in various sectors of the Indian economy.

Global Biofuels Alliance

- The **Global Biofuels Alliance (GBA)** was **officially launched on the sidelines of the G20 Summit in New Delhi**. The **GBA is a key initiative** under India's G20 presidency and aims to **promote international cooperation and the use of sustainable biofuels, as well as facilitate global biofuels trade and provide technical support for national biofuel programs**.
- The **alliance was initiated by nine countries, including India, the US, Brazil, Argentina, Bangladesh, Italy, Mauritius, South Africa, and the United Arab Emirates, with Canada and Singapore as observer countries**. In total, **19 countries and 12 international organizations have agreed to join the GBA**. The alliance will focus on **securing biofuel supplies, ensuring affordability, and promoting sustainability**.

India - Middle East - Europe Economic Corridor (IMEC)

- On the **sidelines of the G20 Summit in New Delhi**, several countries, **including India, the US, Saudi Arabia, the European Union, the UAE, France, Germany, and Italy, signed a Memorandum of Understanding (MoU) to establish the India - Middle East - Europe Economic Corridor (IMEC)**. The move **comes in response** to concerns about **unsustainable debt and geopolitical implications associated with China's BRI projects**.
- **IMEC is envisioned as a network of transport corridors comprising railway lines and sea lanes to promote economic integration between Asia, the Arabian Gulf, and Europe**. This initiative is part of the **Partnership for Global Infrastructure Investment (PGII)**, which aims to **fund infrastructure projects in**

developing countries through public and private investments, offering an alternative to the BRI.

Import Management System

- India is considering a new **"import management system"** for **IT hardware**. Under this system, finished IT hardware like laptops, personal computers, and servers could only be imported from **"trusted geographies," effectively targeting imports from China**.
- The **telecom sector in India** has implemented a **similar strategy** with the **"trusted telecom portal"** and the **National Security Directive on Telecommunication Sector (NSDTS)**. Telecom companies are required to use **"trusted products"** from **"trusted sources"** in their networks, excluding Chinese companies.
- India's **imports of electronic goods and laptops/computers from China have increased in recent years, making it an area of high import dependency**. **China accounts for a significant portion of India's imports** in this category, which has raised concerns about over-reliance on Chinese imports in the IT sector.

"Gujarat Declaration,"

- The **World Health Organization (WHO)** has **unveiled the "Gujarat Declaration,"** the outcome document of the **first WHO Traditional Medicine Global Summit 2023**. **India, as the host of the WHO Global Traditional Medicine Centre in Jamnagar, Gujarat, plays a pivotal role in advancing the summit's action agenda**.
- The **declaration outlines measures to integrate TCIM into national health systems, promote standardized documentation, and establish a global network of TCIM reference clinical centers**. It also highlights the role of digital health technologies and emphasizes the importance of biodiversity conservation and the rights of indigenous peoples in TCIM (traditional, complementary, and integrative medicine).

Culture Corridor-G20 Digital Museum

- The **G20 Summit** is set to **showcase the rich art and culture of its member nations** through an **exhibition at the Bharat Mandapam venue**. The **second level of Bharat Mandapam will feature both physical and digital displays of iconic artworks from all 20 member countries and 9 guest nations**.





These submissions span five categories: cultural significance, iconic masterpieces, intangible

cultural heritage, natural heritage, and artefacts related to democratic practices

CONGRATULATIONS



IBPS RRB PO & CLERK 2022

Exceptional Eleven



Ankita Kawale



Darshna Kharabi



Tejashri Khorate



Divya Choudhari



Pranjal Dholne



Vivek Kothare



Dnyaneshwar Talimkar



Rushikesh Bankar



Suraj Sarang



Vishal Sutar



Tushar Waghmode



WINNER INSTITUTE

India's Best Banking Institute

☎ 99 23 125 666 / 99 23 225 666





Books and Authors

"People's G20"

- **Apurva Chandra**, the **Secretary of the Ministry of Information and Broadcasting**, introduced an **e-book** titled '**People's G20**,' which provides a comprehensive **perspective** on **India's G20 Presidency**.

India & the G20

- Legacy & Prospects for Multilateralism amidst a Polycrisis by **Patrick Bond** and **Sonal Raghuvanshi**
- India's G20 Presidency is occurring at a crucial moment in the history of the world economy; as such it is important to ask what India's role would be sitting on this high table. This compendium brings together diverse voices that are not afraid of asking difficult questions, or presenting analyses that diverge from the mainstream narratives and attempt to provide a much-needed grounded analysis of the G20 framework.

20 Years of G20

- Global Cooperation to Building Consensus Edited by **Rajat Kathuria** and **Prateek Kukreja**
- book reviews the past 20 years of the G20, since it was conceptualized as a replacement for the G-7. While issues such as global financial order have been a constant area of discussion, one of the failures has been not recognizing and acknowledging the importance of issues like trade, climate change and future of work. Featuring academic papers by experts in the area, this book provides a platform for the necessary discourse on these issues.

India in the G20

- Rule-taker to Rule-maker Edited by **Manjeet Kripalani**
- This book analyses the **importance of the G20** to India, its role so far, and how it can leverage its presidency year to be an influential author of new global rules.

Fire on the Ganges

- **Radhika Iyengar** is the author of the book '**Fire on the Ganges: Life Among the Dead in Banaras**,' released by **HarperCollins**.
- Fire on the Ganges is the first attempt to **chronicle the everyday realities of the Doms in Banaras**. It plunges into Banaras's historical past, while

narrowing its lens on a few spirited characters from the Dom community. Through their tales of struggle and survival, loss and ambition, betrayal and love, it tells the at-times-heartbreaking, at-times-exhilarating story of a community struggling to find a place beyond that accorded to it by ancient tradition.

'Ajay to Yogi Adityanath'

- The recently launched graphic novel, '**Ajay to Yogi Adityanath**,' has made history by achieving the highest number of book launches, earning it a place in the Asia Book of Records. This remarkable novel, penned by renowned author **Shantanu Gupta**, delves into the **life of Uttar Pradesh Chief Minister Yogi Adityanath**, tracing his journey from humble beginnings to the pinnacle of political leadership.
- Shantanu Gupta is a famous writer who has penned two bestseller novels. His latest graphic novel based on the life of Yogi Adityanath has so far been launched in eight states, namely, UP, Delhi, West Bengal, Tamil Nadu, Karnataka, Uttarakhand, Andhra Pradesh and Assam.

'Pitchside: My Life in Indian Cricket'

- A book titled '**Pitchside: My Life in Indian Cricket**' by long-term cricket administrator **Amrit Mathur**. In the book, Mr. Mathur brings alive insightful first-person accounts of some of Indian Cricket's most memorable moments. Anecdotes, events, and matches are described from the perspective of an insider who has seen the game and the players up close for over three decades.

"Kargil: Ek Yatri Ki Jubani"

- **Rishi Raj's** new book "**Kargil: Ek Yatri Ki Jubani**" was released by **Ajay Bhatt**, **Minister of State (MoS), Ministry of Defence (MoD) at the Constitution Club of India, New Delhi, Delhi**. The book pays tribute to the Martyrs of Kargil War and was published by Prabhat Prakashan. The book and illustrations – "**Kargil: Ek Yatri Ki Jubani**" – authored by renowned writer **Shri Rishi Raj**, and published by Prabhat Prakashan.

"As the Wheel Turns"

- **Former Vice President of India M Venkaiah Naidu** released a book named "**As the Wheel**





Turns” on July 20, 2023, in Chennai, Tamil Nadu. The book is authored by Rayala Corporation CEO Ranjit Pratap and chronicles his triumphs and challenges in the corporate world.

“India’s Finance Ministers: From Independence to Emergency (1947-1977)”

- Journalist A.K. Bhattacharya has authored a new book titled “India’s Finance Ministers: From Independence to Emergency (1947-1977)”. It is the story of India’s unforgettable finance

ministers who shaped India’s economy in the first thirty years after Independence.

“Droupadi Murmu: From Tribal Hinterlands to Raisina Hill”

- Journalist Kasturi Ray has authored a new book titled “Droupadi Murmu: From Tribal Hinterlands to Raisina Hill”. The book encapsulates the journey of a tribal girl who defied all odds to grow up into an institution signifying resilience, determination and grit

CONGRATULATIONS!



Punjab National Bank Credit Officer



**Shubham
Mhaske**



**Mahesh
Bansode**



**Shubham
Gholap**



WINNER INSTITUTE

Since 2010

India's Best Banking Institute

FOLLOW US ON    



99 22 41 6666





Summit and Conference

New Delhi G20 Summit

- The Cabinet lauded the vision of **Prime Minister Narendra Modi in setting out various aspects of the theme 'One Earth, One Family, One Future'**. The Prime Minister's approach of **Jan Bhagidari involved broad sections** of our society in the G20 programmes and activities. The **200 plus meetings in 60 cities** represented an unprecedented footprint for G20 events. As a result, the Indian G20 Presidency was truly people-centric and emerged as a national endeavour.
- The holding of the **'Voice of the Global South' Summit was a unique aspect of India's Presidency**. It is a matter of particular satisfaction that India's initiative led to the **African Union being accepted as a permanent member of the G20**.
- The **conclusion of the India-Middle East-Europe Economic Corridor Agreement and the Global Biofuels Alliance** during the Summit were also developments of considerable significance.

Gender Samvaad

- The **fourth edition of 'Gender Samvaad,'** a collaborative initiative by the **Deendayal Antyodaya Yojana-National Rural Livelihoods Mission (DAY-NRLM)** and the **Institute for What Works to Advance Gender Equality (IWWAGE)**, brought together thousands of participants in a virtual event. This platform aims to create awareness about **DAY-NRLM's gender-focused initiatives in India**, with a **specific focus on amplifying the voices of states and self-help group (SHG) members**.
- The event highlighted the **extensive efforts made by DAY-NRLM to empower women** and establish model institutions addressing women's concerns in rural areas. These initiatives have been primarily carried out through the **Gender Resource Centre platform**.

International Conference on Dam Safety

- The **Ministry of Jal Shakti's Department of Water Resources, River Development, and Ganga Rejuvenation is organizing the International Conference on Dam Safety (ICDS) from September 14th to 15th, 2023, in Jaipur**. The conference will be inaugurated by the **Vice President of India, Jagdeep Dhankhar**, under

the **theme "Safe & Secure Dams Ensure Nation's Prosperity."**

- This global conference will bring together experts and leaders in dam safety from India and around the world. This event focuses on **enhancing dam safety, discussing cutting-edge topics, and highlighting the Dam Rehabilitation and Improvement Project (DRIP) Phase II and III**. **Technical sessions**, exhibitions, and cultural programs are planned, emphasizing the significance of water conservation and management.
- **ICDS 2023 aims to strengthen dam safety globally** by facilitating discussions among experts and leaders in the field and promoting the importance of safe dams
- India has over **6,000 dams**, ranking it third globally in large dams. Ensuring their safety is crucial due to their multifaceted roles in **water supply, irrigation, hydropower, flood protection**, and more.
- The **Dam Safety Act (DSA) 2021** mandates the establishment of the National Committee on Dam Safety, National Dam Safety Authority (NDSA), State Committee on Dam Safety, and State Dam Safety Organisation. It requires dam owners to have dedicated Dam Safety Units, Emergency Action Plans, and regular safety evaluations.

'Green Hydrogen Pilots in India' Conference

- In preparation for the **18th G20 Summit**, a day-long conference titled **"Green Hydrogen Pilots in India"** was scheduled to take place in **New Delhi on September 5, 2023**. The event, hosted by NTPC Ltd., India's leading integrated power producer, highlighted various green hydrogen pilot projects undertaken by both public and private sector companies across India.
- Participants will have the opportunity to explore these projects, gain insights into clean energy's future, and engage in discussions to address technological challenges, establish local supply chains, and enhance techno-economic feasibility.
- The **conference supports the goals of the National Green Hydrogen Mission by promoting green hydrogen initiatives**. It is expected to inspire collective efforts and advancements in clean energy, contributing to India's sustainable future





National Conference on KCC (Kisan Credit Card) for Fisheries

- **Union Minister of Fisheries, Animal Husbandry, and Dairying, Shri Parshottam Rupala**, will preside over a **one-day "National Conference on KCC for Fisheries"** on **September 4, 2023, in Mumbai, Maharashtra**. This event, jointly organized by the **Department of Fisheries (DoF) and the Department of Animal Husbandry Dairying (DAHD)**, aims to tackle pressing on-ground issues in the fisheries sector.
- The conference will also involve representatives from **financial institutions like RBI and NABARD**. The program, conducted in a hybrid mode, anticipates around **500 participants**. During the event, **Minister Rupala** will distribute **KCC cards to eligible fishers and fishermen**, and stakeholders will discuss the way forward for the sector. Fisheries and aquaculture are crucial for food, nutrition, and employment, supporting **2.8 crore fishers and fishermen**.
- The **KCC scheme was extended to fishers and fish farmers in 2018-19 to provide working capital support**. It simplifies credit delivery and financial inclusion in agriculture and fisheries sectors, playing a vital role in income generation and equitable growth. It was promoted by the government through **awareness campaigns and mobilization drives**. This resulted in the issuance of **1.49 lakh KCCs to date**.

Global India AI 2023 conference

- The **Ministry of Electronics and Information Technology** is set to host the **Global India AI 2023 conference in October**. The event aims to bring together prominent players in the field of **Artificial Intelligence (AI)**, including researchers, startups, and investors from **India and worldwide**. Topics to be covered include **Next Generation Learning, Foundational AI models, AI's applications in healthcare, governance, electric vehicles, research trends, computing systems, investment prospects, and nurturing AI talent**.
- The conference is steered by **Shri Rajeev Chandrasekhar, Union Minister of State for Skill Development, Entrepreneurship, Electronics & IT**, with the goal of shaping the future of AI across sectors. The event will highlight India's AI initiatives such as **DI Bhashini, India Datasets Program, and Future Skills program**. It is

poised to become a significant annual fixture for the global AI industry.

Global Skills Summit

- The **14th edition** of the **Global Skills Summit** in **Delhi**.
- The **theme of the two-day Summit** is **building skills, empowering youth, and creating a future**.
- The Summit aims to **focus on creating a road map for a high-quality industry-led skilling ecosystem in India**.

14th World Spice Congress:

- The **14th edition** of the **World Spice Congress (WSC)** commenced in **Vashi, Navi Mumbai**.
- This **three-day event** is being meticulously organized by the **Spices Board India, a subsidiary of the Ministry of Commerce and Industry**, in collaboration with several **trade bodies and export forums**.
- India, often referred to as the **'Spice Bowl'** of the world, is known for **producing high-quality, rare, and medicinal spices**.
- The **World Spice Congress (WSC)** aims to create **new opportunities for the international trade of Indian spices**.

United Nations Commission on International Trade Law (UNCITRAL) South Asia conference,

- This significant event was jointly organized by the **Ministry of External Affairs, UNCITRAL, and the organization's national coordination committee for India**.
- The conference saw the **presence of notable dignitaries, including Minister of State for External Affairs, Rajkumar Ranjan Singh, Chief Justice of India, DY Chandrachud, and Attorney General R Venkataramani**.

World's Premier Fintech Conference

- **GFF 2023** revolves around a **central theme** that embodies the **fintech industry's aspirations and responsibilities**.
- **Theme: "Global Collaboration For A Responsible Financial Ecosystem, Inclusive, Resilient, Sustainable."**
- The **Global Fintech Fest (GFF)** is set to reclaim its title as the **world's largest fintech conference in 2023**. This year's event promises to be a





spectacular showcase of innovation and collaboration in the fintech industry

Meeting of the Ministers of Law and Justice of SCO Countries

- The **10th meeting of the Ministers of Law and Justice of SCO countries** was convened via video conferencing, where several key initiatives and cooperative efforts were discussed. During this meeting, **India reaffirmed its commitment to the Shanghai Cooperation Organisation (SCO)** by extending support to member countries in enhancing their legal and judicial capabilities.
- India expressed its deep commitment to digital data protection and urged SCO member countries to prioritize this issue. The ministers resolved to work together to protect digital data and develop a safe and secure global digital ecosystem.

- The meeting concluded with the announcement that the next meeting of **SCO Ministers for Law and Justice** will be held in the Republic of Kazakhstan in 2024

43rd ASEAN Summit

- The **43rd ASEAN Summit, hosted by Indonesia from September 5th to 7th,**
- **Theme: "ASEAN Matters: Epicentrum of Growth"**
- **Indonesia aims to retain the region's position as the world's center of economic growth.**
- **Total ASEAN countries 10.**
- The **ASEAN-Indo-Pacific Forum (AIPF)** meeting provided a platform for exploring the evolving dynamics in the Indo-Pacific region, fostering cooperation, and enhancing regional security.

First Time In History !

Winner Institute is the Only Institute in Maharashtra Which Gives Selections

As

 **RBI GRADE-A OFFICERS**

Congratulations

Shafiya Tamboli

Dhiraj Sarve

Sachin Maher

 **WINNER INSTITUTE**
India's Best Banking Institute





Report and Ranking

Global Innovation Index 2023

- India retains **40th rank out of 132 economies** in the **Global Innovation Index 2023** rankings published by the **World Intellectual Property Organization**. India has been on a rising trajectory, over the past several years in the Global Innovation Index (GII), from a rank of 81 in 2015 to 40 in 2023.
- The **Confederation of Indian Industry (CII)** has also been collaborating in India's journey towards an innovation-driven economy. This year, **the NITI Ayog, in partnership with the CII and the World Intellectual Property Organisation (WIPO)**, is hosting, virtually, the India Launch of the **GII 2023** on 29th September 2023
- For the 13th year in a row, Switzerland is the most innovative economy in 2023 followed by **Sweden, the United States, the United Kingdom and Singapore**.
- Apart from China, there are only four other middle-income economies among the top 40 economies, namely, **Malaysia (36th), Bulgaria (38th), Türkiye (39th) and India (40th)**.

World University Rankings

- The 20th edition of the World's Best Universities by the **Times Higher Education (THE)** rankings has been unveiled, showcasing the top higher education institutions globally.
- The 2024 edition is the largest to **date, featuring 1,904 universities from 108 countries** and regions, evaluated across 18 performance indicators reflecting their core missions.
- **The Indian Institute of Science (IISc) Bangalore** has made history by securing the top position among Indian universities.
- Leading the pack is the **University of Oxford, followed by Stanford University, and the Massachusetts Institute of Technology (MIT). Harvard University, University of Cambridge (UK), Princeton University, California Institute of Technology (Caltech), Imperial College London, University of California, Berkeley, and Yale University** round out the top 10.
- The List continues to be predominantly dominated by U.S. universities.

World Talent Ranking

- The **2023 World Talent Ranking**, released by the **International Institute for Management Development (IMD)** on September 27th, has brought both good news and areas of concern for India. While the nation has shown improvements in infrastructure, it has **slipped four spots** to the **56th position** (Out of 64 economies) compared to its 52nd position in the 2022 ranking.
- In the **IMD World Talent Ranking for 2023**, Switzerland secured the top position, followed by **Luxembourg** in second place, and **Iceland, Belgium, and the Netherlands** rounding out the top five. The **United States ranked 15th, China at 41st** place, and the **UK at 35th. Brazil (63rd) and Mongolia (64th)** occupied the bottom two spots.

Gender Inequality's Impact on Women and Cancer

- A newly released report by the **Lancet Commission** highlights the profound effects of gender inequality on women's experiences with cancer prevention, care, and treatment. Despite similar cancer burdens, women face significant disparities due to unequal power dynamics in society. The report, titled **"Women, power, and cancer: A Lancet Commission,"** underscores the urgent need for an intersectional feminist approach to address these inequities.

India Ageing Report 2023

- India is on the cusp of a significant demographic shift, as revealed by the **India Ageing Report 2023**, jointly **released by the International Institute for Population Sciences and the United Nations Population Fund**. By 2050, more than 20 percent of India's population is expected to be elderly, signifying a rapid aging trend. This report sheds light on the changing age composition of India and its potential implications.
- The report highlights that the number of elderly individuals will grow substantially in relation to the population of children aged 0-14 years. Furthermore, the working-age population (15-59 years) is projected to decline. Notably, women are expected to outlive men, leading to a larger population of older women, particularly in rural areas.





- The report provides insights into regional disparities in life expectancy. In India, a 60-year-old man can expect to live another 18.3 years, while women can anticipate 19 years.
- Notably, these figures can vary substantially from state to state, with states like Kerala and Himachal Pradesh showing a more significant life expectancy advantage for women.

UNESCO World Heritage List

- **Santiniketan**, the cultural and educational hub founded by Nobel laureate Rabindranath Tagore, has earned a coveted spot on **UNESCO's World Heritage List**. This recognition marks a significant milestone for India and celebrates the enduring legacy of this unique institution located in Bengal's Birbhum district.
- Hoysala-era temples were added as to UNESCO's World Heritage List thus becoming the 42nd site from India.

World Heritage List of India

- India has **6th highest number of WHS** in the world (Italy is 1st with 58).
- Total number of World Heritage Site - **42**
- Total cultural heritage sites - **34**
- Total natural heritage sites - **7**
- Mixed heritage - **1** (Khangchendzonga National Park in Sikkim).
- 1st WHS from India - Taj mahal, Agra Fort, Ajanta and Ellora caves all listed in 1983.
- Latest addition in WHS List- 42nd is Sacred Ensembles of Hoysala Temples and 41st is **Santiniketan** in 2023.
- Dholavira in Gujarat is the only site of Indus valley civilisation in World Heritage List from India.

The World Best Countries Report 2023

- **Switzerland** has once again claimed the title of the **world's best country**, according to the latest **U.S. News & World Report's annual Best Countries rankings**. This marks Switzerland's second consecutive year at the pinnacle and its **sixth time overall** as the No. 1 nation on the list.
- Switzerland's followed by **Canada** at No. 2, **Sweden** at No. 3, **Australia** at No. 4, and the **United States** at No. 5
- In 2023, India's ranking improved by one position, securing the **30th spot** with an **overall score of 40.8**. In the previous year, in 2022.

India Smart Cities Awards 2022

- The **India Smart Cities Awards 2022**, organized by the Union Housing and Urban Affairs Ministry, have recognized **Indore** as the best city and **Madhya Pradesh** as the best state in the Smart Cities Mission. The awards celebrate the progress and achievements of cities and states in promoting sustainable development and enhancing the quality of urban life across India.
- **Second Best City: Surat; Third Best City: Agra**
- **Second Best State: Tamil Nadu ; Shared Third Best State: Rajasthan and Uttar Pradesh**

State of the Rhino Report

- A recent report from the International Rhino Foundation sheds light on the escalating threat climate change poses to rhino populations in Africa and Asia. Beyond the persisting challenges of poaching and habitat loss, climate change induced droughts, floods, and habitat disruptions are adding complexity to the conservation efforts aimed at protecting these magnificent creatures.
- As of the latest estimates, the global population of rhinos stands at slightly over 26,000 individuals.
- **The Indian state of Assam is home to the largest population of greater-one horned rhinos, with more than 90% in Kaziranga National Park**

The Gender Snapshot 2023 Report

- The United Nations has released a report stating that the goal of achieving gender equality by 2030, as set by the U.N., is unlikely to be realized due to deeply ingrained biases against women in various sectors such as health, education, employment, and politics. The report, titled "**The Gender Snapshot 2023**," highlights that active resistance to gender equality and chronic underinvestment are key factors slowing progress and even leading to reversals in some cases.
- Issues like unequal access to sexual and reproductive health, political underrepresentation, economic disparities, and a lack of legal protection contribute to this challenge.
- The report also calls attention to setbacks for women and girls in conflict affected regions and the adverse impact of climate change.
- It estimates that up to 129 million girls and young women may be out of school globally in 2023, with an estimated 110 million still out of school in 2030 if current trends persist.





- The report estimates that \$6.4 trillion per year is required across 48 developing countries to achieve gender equality in various key areas by 2030.

Swachh Vayu Sarvekshan 2023

- Union Environment, Forest, and Climate Change Minister Bhupender Yadav announced the results of the **Swachh Vayu Sarvekshan 2023** (clean air survey) in Bhopal, with Indore, Madhya Pradesh, claiming the top spot among million-plus population cities. The **survey, in its second year,**

included 130 identified cities under the National Clean Air Programme. Agra, Uttar Pradesh, secured the second rank, followed by Thane, Maharashtra, in third place.

- The awards were categorized by city population size based on the 2011 census. In the three to ten lakh population category, Amravati, Maharashtra, secured the top rank. Himachal Pradesh towns Parwanoo and Kala Amb took the lead among cities with under three lakh population, with Angul, Odisha, in third place. Cities were evaluated on various factors related to air quality, with a shift in rankings compared to the previous year.





Sports

Indian Men's Hockey team beat Pakistan to win Men's Hockey 5s Asia Cup 2023

- The **Indian Hockey team beat Pakistan** in a penalty shootout in the final and **won** the inaugural **Men's Hockey 5s Asia Cup 2023** in **Salalah, Oman**.
- India also **qualified** for the **FIH Men's Hockey5s World Cup Oman 2024**.
- This is the first time in three meetings that India has beaten Pakistan in the Hockey 5s format.
- **Hockey India President Dilip Tirkey** congratulated the team on qualifying for the **FIH Men's Hockey5s World Cup Oman 2024** and winning the **Gold medal**.

Tennis phenom Coco Gauff won US Open women's singles final 2023

- **American teenager Coco Gauff** has won the **US Open 2023**, clinching her **first Grand Slam title** with a battling **win over Aryna Sabalenka of Belarus**.
- The championship **match** marked the first appearance by both athletes in a U.S. Open final.
- She last played in a Grand Slam final in 2022, losing the French Open to Iga Swiatek.
- In August 2023, the teen won the Western & Southern Open in Cincinnati, becoming the youngest player to do so.

Novak Djokovic won US Open 2023 Men's Singles final title 2023.

- **Novak Djokovic created history by winning 24th Grand Slam title in US Open 2023 Men's Singles final 2023.**
- He defeated **Daniil Medvedev of Russia**.
- He already the oldest French Open singles champion, became the oldest US Open singles champion in the pro era.
- In Women's Doubles 16th seed **New Zealand-Canadian combination of Erin Routliffe and Gabriela Dabrowski** defeated 12th seed pair of German-Russian duo Laura Siegemund and Vera Zvonareva to **win the US Open 2023 title**.

Virat Kohli becomes fastest ODI player to reach 13,000 runs

- **Virat Kohli** stunned fans after **he broke Sachin Tendulkar's record** of the **fastest batter to score 13000 runs in ODI**.

- The 34-year-old record of fellow Indian veteran Sachin Tendulkar (321 innings), achieving in just 267 innings.
- With this century, Kohli has now scored four consecutive 100s at this stadium, the joint-most highest centuries at a single venue alongside South African
- He became the quickest batter to reach this milestone, Ponting and Sangakkara

Kiran George clinches Indonesian Masters title 2023 in Badminton

- Indian badminton player **Kiran George** clinched the **men's singles title at the Indonesia Masters 2023 in Medan, North Sumatra**.
- Kiran George, **50th** in the badminton rankings, beat **world No. 82 Koo Takahashi of Japan** to claim his second BWF World Tour Super 100 badminton title.
- He **won the Odisha Open 2022**, beating compatriot **Priyanshu Rawat** in the final.
- He was the only **Indian** who **reached the final** at the **Indonesia Masters 2023**.

Maharashtra wins 5th National Wheelchair Rugby Championship 2023

- **Maharashtra** clinched the title of champions in the **5th National Wheelchair Rugby Championship 2023** by securing a convincing **victory over Karnataka**.
- **Aim:** To promote and expand the sport of wheelchair rugby across the nation.
- It was organized by The Indian Rugby Football Union (Rugby India), the governing body for rugby in India.
- It was conducted in association with the Wheelchair Rugby Federation of India and Mitsubishi Corporation.

India beats Sri Lanka by 10 Wickets in Colombo to win Asia Cup 2023 title

- The **Indian cricket team bagged Asia Cup 2023 in Colombo by defeating Sri Lanka**.
- India's **Mohammed Siraj** brought Sri Lanka down to their knees with a **six-wicket haul**.
- He was followed by **Hardik Pandya** who took three wickets, along with one wicket by **Jasprit Bumrah**.





- **Mohammed Siraj** was declared **player of the match** and **Kuldeep Yadav** **player of the series**.
- Ishan Kishan at 23 and Shubman Gill at 27 remained unbeaten.

Indian shooter Elavenil Valarivan wins Gold medal in ISSF World Cup 2023

- **Indian shooter Elavenil Valarivan** has won the **gold medal** in the **women's 10-metre air rifle event** at the **ISSF World Cup 2023** in **Brazil**.
- She defeated **France's Oceanne Muller**.
- This was **Elavenil Valarivan's** second individual ISSF World Cup medal.
- The **third position** was grabbed by **China's Jiale Zhang**, scoring 229 points.

Mohammed Siraj back at No.1 in ICC Men's ODI bowling rankings

- Indian pacer **Mohammed Siraj** re-grabbed the number one position among bowlers in the ICC Men's ODI player rankings 2023.
- His latest **match-winning performance** against **Sri Lanka** in the Asia Cup final provided eight spot leaps to take him to the top.
- **Kuldeep Yadav** is another Indian bowler who made it into the **top ten**.
- **Jasprit Bumrah**, who has come back after a long injury break, climbed up two places to the 27th position.
- **Hardik Pandya** rose eight spots to the 50th rank

ICC releases official Anthem 'Dil Jashn Bole' for Men's Cricket World Cup

- The **International Cricket Council** released the official **Anthem** for the **Men's Cricket World Cup 2023** beginning on the 5th of October.
- The **theme** of the **anthem** is **Dil Jashn Bole** and it features Bollywood superstar **Ranveer Singh** and other popular social media influencers.
- The Cricket World Cup 2023 is being held in India after 12 years.
- The music for the anthem has been prepared by Pritam, and the singers are **Pritam, Nakash Aziz, Sreerama Chandra and Amit Mishra**

India Becomes No 1 Ranked Team In All Formats Of Cricket

- **India** became the **number 1** ranked team in all three formats i.e. **Tests, ODIs and T20Is**, after their 5-wicket won against Australia.

- **India displaced Pakistan** from the top of the ODI rankings while they **lead England in the T20I rankings**.
- In the longest format, they are in the **first place** while **Australia** are **right behind them**.
- The rankings reflect the hard work put in by this team as they chase excellence on the field.

19TH Asian Games, 2023 begins in Hangzhou, China in a colorful ceremony

- The **19th edition** of the **2023 Asian Games** began in Hangzhou city of **China**.
- The two-week extravaganza was declared open in a colorful ceremony by **Chinese President Xi Jinping**.
- Over 12,000 competitors from 45 nations and territories are taking part in 61 disciplines.

India bags Gold medal in Men's 10-meter air rifle event at Asian Game 2023

- **Indian trio Rudranksh Patil, Divyang Panwar, and Aishwary Tomar** clinched **gold** in the **Men's 10m air rifle event in Asian Games 2023**
- India won its first medal in shooting as the **trio of Ramita Jindal, Mehuli Ghosh, and Ashi Chouksey** earned a Silver in the women's 10m air rifle event.
- Indian duo **Arjun Lal Jat and Arvind Singh** won a **silver in men's lightweight double sculls** in the rowing discipline.
- India has secured six medals - **one gold, three silver, and two bronze**

India Women's Cricket Team Wins Gold Medal By Defeating Sri Lanka

- **Indian women's cricket** team won their maiden **gold medal in Asian Games 2023** by defeating **Sri Lanka** by **19 runs** in the final.
- This is a **historic feat** achieved by the **Indian Women's cricket team**.
- India secured a **new world record** and captured the **gold medal** in the men's 10 air rifle team event during the Asian Games 2023.

India's Sift Kaur Samra wins gold in women's 50m Rifle 3-P individual event

- **India's Sift Kaur Samra** won **gold** in the **women's 50m Rifle 3-P individual event** at the **Asian Games 2023** to give India its **fifth gold** at **Hangzhou**.





- In women's 25m pistol shooting event, Indian team comprising of **Manu Bhaker**, **Rhythm Sangwan** and **Esha Singh** also claimed gold medal.
- This brings the overall medal tally for India to **21 - 5 gold, 6 silver and 10 bronze**.

India win gold in 10m Air Pistol Team event in Asian game 2023

- India players **Sarabjot Singh**, **Arjun Singh Cheema**, and **Shiva Narwal** clinched **gold** in the men's **10m air pistol** team event in the **Asian Games 2023**, in **Hangzhou**.
- **Naorem Roshibina Devi** clinched **India's first silver medal** in **women's 60kg Wushu Sanda event**, losing to China's **Wu Xiaowei**.
- **Other Winners:**
Shooting: India clinchs **GOLD** in men's 10m air pistol team event

India bagged Gold medal by Men's Team in 50m Rifle 3P event

- Shooters **Aishwarya Pratap Singh Tomar**, **Swapnil Kusale**, and **Akhil Sheoran** clinched

gold in the **men's 50m rifle 3P team event** in the **Asian Games 2023** in **Hangzhou**.

- **Other Winners**
- The women's Team of **Divya Thadigol**, **Esha Singh**, and **Palak** won the **Silver Medal** in the **10m Air Pistol Women's team event**
- **Anush Agarwala** won the **Bronze Medal** in the **Equestrian Dressage Individual event** at the **Asian Games**.
- To date, India secured **31 medals** including **8 gold, 11 silver, and 11 bronze**

ICC announces official mascots for Cricket World Cup 2023

- The International Cricket Council (ICC) has revealed the two official **ICC mascots** named **'Blaze'** and **'Tonk'** for the **2023 Cricket World Cup** in India.
- **'Blaze'** is a female mascot, bowling at a rapid pace, leaving batters in sheer awe.
- She is adorned with a belt carrying six power cricket orbs, each meticulously prepared for various game-changing tactics.
- **'Tonk'** is a male mascot, with icy-cool composure, making him a batting champion.





Awards

India's Dr. R Ravi Kannan wins Ramon Magsaysay Award 2023

- The Assam-based surgical oncologist **Dr. R Ravi Kannan** has won the Ramon Magsaysay Award 2023 for his revolutionizing cancer treatment in Assam.
- He worked at the Cancer Institute in Chennai before he moved to Silchar in 2007 to join the Cachar Cancer Hospital.
- The Magsaysay Award was **established in 1957** to reward individuals for integrity in governance, courageous service to the people, and pragmatic idealism in democratic societies.

RBI governor Shaktikanta Das ranked top central banker globally

- Reserve Bank of India (RBI) Governor **Shaktikanta Das** has been ranked as the top central banker globally by US-based Global Finance magazine.
- He has been **rated 'A+' in the Global Finance Central Banker Report Cards 2023.**
- He has been placed at the top of the list of three central bank governors who have been rated A+.
- Grades are based on a scale from A to F for success in inflation control, economic growth goals, currency stability, and interest rate management.

P V Satyanarayana receives Dr. M.S. Swaminathan Award

- **P.V. Satyanarayana**, principal scientist at the **Agricultural Research Station, Acharya N.G. Ranga Agricultural University Andhra Pradesh** was presented **8th Dr M.S. Swaminathan award.**
- He received the award in recognition of his contribution to the development of high-yielding rice varieties that exhibit resilience against pests and environmental challenges
- He has also contributed to fine-grain varieties and hybrid rice that have revolutionized agriculture across India.

Shanta Thoutam honored with World Innovation Award at BRICS

- Telangana Chief Innovation Officer **Shanta Thoutam** received the **World Innovation Award at the first BRICS Innovation Forum** hosted in Moscow.

- The award is given for outstanding contribution to Sustainable Development Goal-4 which ensures inclusive and equitable quality education and promotes lifelong opportunities for all.
- She as one of the panelists at the Cloud City Conference, spoke about the initiatives and achievements of Telangana in the space of open data, digital innovation, and urban development.

12 scientists selected for Shanti Swarup Bhatnagar Awards for year 2022

- Country's top annual science prize, Shanti Swarup Bhatnagar Awards were **announced after a gap of two years.**
- This year 2023, **12 scientists will get the awards in seven categories.** **Dr.N. Kalaiselvi, Director General of CSIR announced the awards for the year 2022 in the presence of Union Minister Jitendra Singh.**
- These awards are given every in seven scientific disciplines - physics, biology, engineering, mathematics, medicine, chemistry, and earth sciences.

Shanti Swarup Bhatnagar Prize for Science and Technology	
Awarded for	Research in science in India
Location	Vigyan Bhawan, New Delhi
Presented by	Council of Scientific and Industrial Research Government of India
First awarded	1958

The **Shanti Swarup Bhatnagar Prize for Science and Technology (SSB)** is a science award in India given annually by the Council of Scientific and Industrial Research (CSIR) for notable and outstanding research, applied or fundamental, in biology, chemistry, environmental science, engineering, mathematics, medicine, and physics.





Rail India Technical and Economic Service won Safety Innovation Award 2023

- Rail India Technical and Economic Service Limited has been honored with the 'Safety Innovation Award 2023', under the 'Construction' category, for implementing 'Innovative Safety Management Systems' in its operations.
- The award was presented to RITES' officials during the inaugural function of the **20th Safety Convention organized.**
- RITES, having multi-sectoral presence, has consistently embraced best safety practices in its operations.

Andhra Pradesh: GI tag for 'Atreyapuram Pootharekulu'

- The Department for Promotion of Industry and Internal Trade has announced the issuance of the Geographical Indication tag to "Atreyapuram Pootharekulu."
- It is a sweet made of **rice** and **jaggery**
- The production of the sweet is confined only to the Atreyapuram village on the banks of the Godavari in Andhra Pradesh.
- The tag was allotted after Sir Arthur Cotton Pootharekula Sahakara Sangham, a cooperative society, applied to secure a GI tag for the Pootharekulu sweet.

Legendary actor Waheeda Rehman to receive Dadasaheb Phalke Award

- Information and Broadcasting Minister **Anurag Singh Thakur** announced that veteran actor **Waheeda Rehman** has been chosen for **Dadasaheb Phalke Lifetime Achievement Award 2023**
- The actress has been critically acclaimed for her roles in Hindi films like *Pyaasa*, *Kaagaz ke Phool* and several others.
- A Padma Shri and Padma Bhushan awardee, she has exemplified dedication, commitment and the strength of a Bharatiya Nari who can achieve the highest level of professional excellence

Indore bags Best Smart City spot at National Smart Cities Conclave 2023

- **Indore** has bagged the top spot for the 'Best Smart City' 2022 in India at the **National Smart Cities Conclave 2023 held in the city.**
- Gujarat's **Surat** came in second, while **Agra** in UP secured the **third position** among the smart cities of India.
- **Madhya Pradesh bagged the Best State** in the country, followed by **Tamil Nadu.**
- **Rajasthan and UP** together bagged the third position.
- President felicitated the winners of the fourth edition of the India Smart Cities Award Contest 2022.

GOVERNMENT JOB 2023

Yesterday you said Tomorrow.
Next year you will say Next Year...
Get out of your comfort zone and start preparations today for a brighter future....

Contact WINNER with the legacy of more than years to help you prepare for the jobs in Government Sector.

WINNER INSTITUTE
India's Best Banking Institute

www.wiceindia.com

99 22 41 6666 / 80 87 167 666





Appointments

1. Geetika Srivastava, a member of the 2005 batch of the **Indian Foreign Service (IFS)**, has been **appointed** as the **first woman Charge d'Affaires (CAD)** at the **High Commission of India in Islamabad, Pakistan**.

She will **succeed Dr M Suresh Kumar**, who will be returning to New Delhi. Recently, Pakistan has appointed Saad Ahmad Warraich as its new CAD in High Commission of Pakistan in New Delhi, Delhi.

2. The Finance Industry Development Council (FIDC), the representative body for asset and loan financing of **Non-Banking Finance Companies (NBFCs)**, has **appointed Umesh Revankar** as its **new chairman**.

He has been appointed for a **period of 2 years** with effect from **23rd August 2023**.

He is **currently serving** as the **Executive Vice Chairman** of **Shriram Finance Limited**.

3. General Brice Oligui Nguema, **Chief of the Gabonese Republican Guard**, has been **appointed** as the **Transitional President** of **Gabon** and **Chairman** of the **Committee for the Transition and Restoration of Institutions**.

He has been **appointed** after **deposing President of Gabon Ali Bongo Ondimba**, who officially won a third term in the presidential election with **64.27%** of the vote.

4. Former Singapore deputy Prime Minister Tharman Shanmugaratnam has been **elected** as the **9th President of Singapore** after securing **70.4%** of more than **2.48 million valid votes cast**.

He will **succeed Halimah Yacob**, Singapore's first female President elected without a consent in 2017 whose term will conclude on **13th September 2023**.

5. The Appointments Committee of the Cabinet (ACC) has **approved** the **appointment** of **Jaya Verma Sinha**, **Indian Railway Management Services (IRMS)**, **Member (Operations & Business Development)**, **Railway Board** to the post of **Chairman and Chief Executive Officer (CEO)**, **Railway Board**.

She has been **appointed** for a **period** with effect from the date of assumption of charge on or after **1st September 2023** till the date of her superannuation and her re-employment on the post with effect from **1st September 2023** till **31st August 2024** on usual

terms and conditions, or until further orders, whichever is earlier. She is first woman CEO and chairperson of Railway Board. She has succeeded Anil Kumar Lahoti.

6. The Parliament of the Republic of Vanuatu has **elected Sato Kilman**, a **former Prime Minister** and **leader of the People's Progressive Party**, as the **new Prime Minister of Vanuatu**.

This marks his **5th term** as the **PM of Vanuatu**.

7. Swaraj Tractors, a subsidiary of **Mahindra & Mahindra Limited**, has **appointed former Indian cricket team captain Mahendra Singh Dhoni** as its **new brand ambassador**. The announcement has been made during the launch of the company's **lightweight tractors**.

He will feature in the newly launched advertising campaign for the brand.

8. N.V. Ramana, **former Chief Justice of India (CJI)**, has been **appointed** as a member of the **prestigious International Mediator Panel** of the **Singapore International Mediation Centre (SIMC)**.

A **letter of appointment** has been presented to him by **George Lim**, **Chairman of SIMC in Singapore**.

9. The National Association of Software and Service Companies (NASSCOM) has announced the **appointment** of **Rajesh Nambiar**, **Chairman and Managing Director of Cognizant India**, as its **Chairperson**.

He will **replace Anant Maheshwari** (former President of Microsoft India) who was appointed as **Chairman of NASSCOM (2023-24)** in April 2023.

10. Bollywood actor-filmmaker R Madhavan has been **nominated** as the **new President of the Film and Television Institute of India (FTII)** and **chairman** of its **governing council**.

He will **succeed filmmaker Shekhar Kapur** as **FTII president**.

11. The General Body of the International Esports Federation (IESF) has **elected Lokesh Suji**, **Director of Esports Federation of India (ESFI)** and **Vice-President of the Asian Esports Federation (AESF)**, to its **esteemed Membership Committee on a three-year term**.





This election marks the first time that an Indian has become a part of the membership committee of the International Esports Federation.

12. Mahavir Lunawat, Group Founder & MD of Pantomath Capital Advisors Private Limited, has been appointed as the Chairman of the Association of Investment Bankers of India (AIBI) for a period of 2 years starting from September 2023. He has succeeded Anay P Khare, MD (Corporate Finance Division (CFD)) of Axis Capital Limited.

AIBI has also appointed Arjun Mehra, MD of JM Financial, and Prem D'Cunha, Senior Vice President & Head- ECM Execution at ICCI Securities as its Vice Chairman.

13. Tata Steel Limited shareholders has approved the re-appointment of T.V. Narendran as the global Managing Director (MD) and Chief Executive Officer (CEO) for the next five years. This will be effective from September 19, 2023, till September 18, 2028.

14. Dhananjay Joshi, MD, and CEO of Summit Digital, has been appointed as the chairman of the Digital Infrastructure Providers Association (DIPA). He will succeed Akhil Gupta, who has served as Chairman of Bharti Enterprises and Chairman of DIPA since 2011.

Sandeep Girotra, CEO of American Tower India, has been appointed as the new Vice President of DIPA.

These leadership changes will be effective from October 1, 2023.

15. Srinivasan K Swamy, executive chairman of R K Swamy Hansa Group, has been elected as the Chairman of the Audit Bureau of Circulations (ABC) for the term 2023-24. He has replaced Pratap Pawar who served as Chairman for the term 2022-23. Riyad Mathew, Chief Associate Editor and Director of Malayala Manorama Co. Ltd., has been elected as the Deputy Chairman of ABC for 2023-24.

Audit Bureau of Circulations (ABC):

ABC founded in 1948 is a not-for-profit, voluntary organisation consisting of publishers, advertisers and advertising agencies as members. It is in Mumbai, Maharashtra.

16. Atul Malhari Gotsurve, Joint Secretary in the Ministry of External Affairs (MEA), has been

appointed as the next **Ambassador of India to Mongolia**. He will **replace MP Singh as Ambassador**. He has **worked** in the **Latin American and Caribbean (LAC) Division, MEA from 2010-2014 in various capacities**.

From 2014 to 2017, he worked as the Regional Passport Officer of Pune in the State of Maharashtra.

17. Vivek Bhasin has been named the **14th Director of the Bhabha Atomic Research Centre (BARC)**. He was **serving as the Scientist and Director, Nuclear Fuels Group (NFG) of BARC**. He has **succeeded Ajit Kumar Mohanty**.

18. Nihar Malaviya, an Indian-origin publishing executive, has been appointed as the permanent Chief Executive Officer (CEO) of Penguin Random House. He has been serving as the interim CEO for 9 months since 1st January 2023.

He will **replace Markus Dohle**, who left the position after Penguin Random House's failed bid for Simon & Schuster in 2022.

19. The Chairman of Rajya Sabha Jagdeep Dhankhar has recently (Sep'23) reconstituted the panel of vice-chairpersons in the Rajya Sabha with the eight-member panel with 50% of women parliamentarians with effect from 13th September 2023.

For the **first time in the history of Rajya Sabha, the equal representation** has been given to **women members in the panel**.

The **8-member panel will now have four women members, including Bharatiya Janata Party (BJP) MPs Kanta Kardam (Uttar Pradesh), Sumitra Balmik (Madhya Pradesh) and Geeta alias Chandraprabha (Uttar Pradesh); and Biju Janata Dal's Mamata Mohanta (Odisha).**

Male members: Congress' Akhilesh Prasad Singh (Bihar), Aam Aadmi Party's Narain Dass Gupta (Delhi), YSRCP's V Vijayasai Reddy (Andhra Pradesh) and Santanu Sen (West Bengal) from Trinamool Congress. The vice chairpersons are eligible to preside over the house in the absence of the chairman or the deputy chairman.

20. Banmali Agarwala has been **appointed as the new Chairman of the Tata Advanced Systems Limited (TASL), the aerospace and defence solutions division and wholly owned subsidiary of TATA Sons, the holding company of TATA Group.**





He has succeeded Vijay Singh who has retired from the post.

21. Sudhakar Rao Desai, Chief Executive Officer (CEO) of EmamiAgrotech Ltd, has been unanimously re-elected as the President of the IVPA (Indian Vegetable Oil Producers' Association) at the 46th annual general meeting of the association.

Amrendra Mishra, Managing Director of ADM India, and V.K. Jain, Vice-President of Patanjali Foods, have been elected as Vice-Presidents of IVPA.

22. Bollywood actress Katrina Kaif has become the first Indian Brand Ambassador of Japanese apparel brand Uniqlo. The 1-year agreement will

feature the actress in advertising films for the company's 'LifeWear' range of everyday apparel. Uniqlo opened its first store in India in 2019. She has also been named the brand ambassador for Etihad Airways, UAE.

23. Intel Corporation has appointed Gokul Subramaniam as the new President of Intel India. He will be responsible for overseeing the company's comprehensive engineering and design operations. This includes innovation, cross-group efficiencies, and execution of Intel's products in India. He will continue to lead the client platforms and systems in the client computing group (CCG) of Intel. He has succeeded Nivruti Rai.





Defence Related News

Warship 'Mahendragiri' to launch in Mumbai

- The warship 'Mahendragiri' built at Mazagon Dock Shipbuilders Limited was launched in Mumbai.
- It would be launched by **Dr Sudesh Dhankhar** and it is the **seventh ship of the Project 17A Frigates**.
- The warship has been named after a mountain peak in the Eastern Ghats located in the state of Orissa.
- Mahendragiri is a technologically advanced warship and stands as a symbol of India's determination to embrace its rich naval heritage.

INS Sumedha Arrived In Egypt To Participate In 'Exercise BRIGHT STAR-23'

- In a development highlighting India's growing presence on the global military stage, the **Indian Navy's INS Sumedha arrived at Port Alexandria, Egypt, to take part in 'Exercise Bright Star-23.'**
- It marks a historic occasion, with **34 countries participating**, making it the largest joint military exercise ever held in the **Middle East and North Africa region**.
- The Harbour Phase involves an array of activities aimed at planning and executing the Sea Phase

21st EDITION OF INDIA FRANCE BILATERAL NAVAL EXERCISE 'VARUNA' - 2023

- **Phase II of the 21st edition of Varuna (Varuna-23) bilateral exercise** between **Indian and French Navy** was conducted in the **Arabian Sea**.
- The exercise witnessed participation of guided missile frigates, tanker, Maritime Patrol Aircraft and integral helicopters from the two sides.
- **Aim:** To enhance and hone their war fighting skills, improve interoperability and demonstrate their ability to promote, peace, security and stability in the region.

India Air Force to receive first C-295 transport aircraft from Airbus

- The **Indian Air Force** is all set to acquire its **first Airbus C-295 aircraft**.
- India has formalized the acquisition of **56 Airbus C-295 aircraft** to replace the Indian Air Force AVRO fleet.

- Among these, 16 units of the military aircraft will be manufactured in Spain while the rest will be made in India from the manufacturing facility in Vadodara, Gujarat.
- The new aircraft will play a major role in the forces as a tactical military transport aircraft.

Indonesia Kicks Off ASEAN Joint Military Drills

- **ASEAN** began their first-ever joint military drills in **Indonesia** amid rising geopolitical tensions between major powers and protests against China's activities in the South China Sea.
- **Aim:** To develop military skills, including maritime security and patrols, and the distribution of humanitarian assistance and disaster relief.
- All 10 members of the Association of Southeast Asian Nations (ASEAN) will join the exercise, including prospective member East Timor.

DRDO develops P7 Heavy Drop System for Indian Army Special Forces

- **DRDO** has developed the **P7 Heavy Drop System** which is capable of **para-dropping military stores up to 7-ton weight class from IL 76 aircraft**.
- This system is fully indigenous and being manufactured by L&T which makes the platform system, and parachutes manufactured by Ordnance Factory.
- The system would be a force multiplier for armed forces while enabling the rapid delivery of combat stores in far-flung inaccessible areas.

India-US Army to host Indo-Pacific Armies Chiefs Conference

- The **Indian Army and the United States Army** will co-host the **13th Indo-Pacific Armies Chiefs Conference**
- It is a 3 day conference of Chiefs of Armies and delegates of 35 countries in **New Delhi from 25th to 27th September 2023**.
- Theme of 2023 is **"Together for Peace: Sustaining Peace and Stability in the Indo-Pacific Region."**
- **Aim:** To promote peace and stability in the Indo-Pacific region through mutual understanding, and friendship amongst the littoral partners.





19th edition of YUDH ABHYAS to be conducted in Alaska

- The 19th edition of YUDH ABHYAS will be conducted in Alaska, an annual exercise conducted jointly by the Indian Army and the US Army.

- The Indian Army contingent comprising 350 personnel will participate in this edition of the exercise.
- The lead battalion from Indian side is affiliated to **MARATHA Light Infantry Regiment.**



Apprentice Development Officer

CONGRATULATIONS

MEET OUR SUPER LIC WINNERS

 Shivani Dolphode	 Surbhi Thokade	 Apurva Dhapodkar	 Maheshwari Maimkar	 Ratnamala Bainwad	 Sandhya Supe	 Prashant Dhalgude	 Sainath Wantekar	 Rohit Nandavdekar
 Hashad Bandal	 Akshay Mete	 Jyoti Kendre	 Venkatesh Mirdode	 Sarthak Jadhav	 Rohit Dhanuk	 Akash Mule	 Avinash Dhakne	 Mahesh Kalsait
 Omkar Patil	 Shyam Puppawar	 Parth Bandrewar	 Pravin Kolekar	 Akshay Vare	 Tanmay Jadhav	 Kishor Hande	 Rutvik Pathak	 Amardeep Patil
 Deepak Borate	 Ganesh Jalak	 Pankaj Rakh	 Samadhan Wagaadkar	 Nandkishor Dandge	 Sumit Ingale	 Digvijaysingh Thorat	 Akshaykumar Karanjkar	 Akshay Wayal



Since 2010

WINNER INSTITUTE

India's Best Banking Institute

99 22 41 6666

80 87 167 666



Obituaries

1. Jan Jongbloed, the Netherlands' goalkeeper in the 1974 and 1978 World Cup finals, has passed away at the age of 82. He was born on 25th November 1940 in Amsterdam, Netherlands.

He played a total amount of 717 professional games and made the second-highest number of appearances in the history of the Eredivisie, behind only Pim Doesburg. He was a part of the Netherlands team, popularly known as "Clockwork Organe".

2. Heath Hilton Streak, former captain of Zimbabwe cricket team, has passed away at the age of 49 in Matabeleland in south-western Zimbabwe. He was born on 16 March 1974 in Bulawayo, Zimbabwe.

He represented Zimbabwe in 65 Tests and 189 One Day Internationals (ODIs) between 1993 and 2005. He was the all-time leading wicket taker for Zimbabwe in Test cricket with 216 wickets and in ODI cricket with 239 wickets. He remains the only Zimbabwean cricketer to have taken over 100 Test wickets and completed the double of 2000 runs and 200 wickets in ODIs.

3. N Valarmathi, an Indian Space Research Organisation (ISRO) scientist, who lent her voice to countdowns for rocket launches, has passed away after a cardiac arrest. She was born on 31st July 1959 in Ariyalur, Tamil Nadu.

She became the project director of India's first indigenously-developed radar imaging satellite, RISAT-1, which was launched successfully in 2012. She voiced the launch of India's first successful mission, Chandrayaan-3, which ultimately became her final one.

She is the first person to receive the Abdul Kalam Award, instituted in 2015 by the Government of Tamil Nadu.

4. Dennis Austin, who co-created PowerPoint, has passed away at his home in Los Altos, California, USA at the age of 76. He was born on 28th May 1947 in Pittsburgh city of Pennsylvania, USA.

He along with Robert Gaskins created the PowerPoint for the software company Forethought and released it in 1987.

Microsoft then acquired the firm and integrated PowerPoint into its suite of Office programs.

5. The United Kingdom (UK) scientist Ian Wilmut has passed away at the age of 79. He was born on 7th July 1944 in Hampton Lucy, UK. He led the team that created the first mammal cloned from an adult cell, popularly known as 'Dolly' the Sheep, in 1996.

Dolly, named after country singer Dolly Parton, was created using a process called somatic cell nuclear transfer (SCNT).

He was also a part of the team that created Frostie, the first calf to be born from a frozen embryo in 1973.

6. Mircea Snegur, who served as the first President of Moldova, has passed away in Chisinau, Moldova. He was born on 17 January 1940 in Trifănești, Moldova.

He became the President of the Moldovan Soviet Socialist Republic in 1990 following the approval from the Moldovan Supreme Council. He led the Republic of Moldova to its proclamation of independence on 27th August 1991.

7. N.S. Srinivasan, a renowned highway and traffic expert and Founder Director of the National Transportation Planning and Research Centre (NATPAC), has passed away at the age of 89 in Chennai, Tamil Nadu.

He was born in Nallur, Tamil Nadu. He served as the Head of the Traffic and Transportation Division of the Central Road Research Institute, New Delhi for 13 years from 1963 to 1976.

He also served as a World Bank advisor to prepare a highway network plan for Yemen.

He has been acknowledged as the "man who brought order to Delhi's road", Roving Organizer", "Pioneer in Traffic Planning", and "Father of Traffic Engineering in India".

8. Noted Indian American Writer-Filmmaker Gita Mehta has passed away at the age of 80 in New Delhi. She was born in 1943 in Odisha. She is the elder sister of Odisha Chief Minister Naveen Patnaik.

She was conferred India's fourth highest civilian honour, the Padma Shri, in the field of literature and education in 2019. She declined the award citing its timing ahead of the May 2019 elections.

She has written books such as 'Karma Cola', 'Snake and Ladders', 'A River Sutra', 'Raj' and 'The Eternal Ganesha'.





9. Noted Hindustani classical vocalist Malini Rajurkar has passed away at the age of 82 in Hyderabad, Telangana. She was born in 1941 in Ajmer, Rajasthan.

She was an **exponent** of the **Gwalior Gharana** and was known for her **mastery** of the '**Khayal**' and '**Tappa**' styles in **Hindustani classical music**. She has received several awards, including the prestigious **Sangeet Natak Academy Award** in 2001 for her contribution to Hindustani vocal music.

10. Saroja Vaidyanathan, a choreographer, guru and a notable exponent of Bharatanatyam, has passed away at the age of 86 due to lymphoma disease in New Delhi. She was born on Bellary, Karnataka on 19th September 1937.

She was conferred the **Padma Shri** in 2002 and the **Padma Bhushan** in 2013 by the Government of India. She **wrote** a number of **books** on **Bharatanatyam** and **Carnatic music** including '**The Classical Dances of India**', '**Bharatanatyam - An In-Depth Study**', '**Carnataka Sangeetham**', and '**The Science of Bharatanatyam**'.

She also established the '**Ganesa Natyalaya**' in 1974.

11. Giorgio Napolitano, former President of Italy (2006 to 2015) and leader of Italian Communist Party, has passed away at the age of 98 in Rome, Italy. He was born in 1925 in Naples, Italy. He was the longest serving and longest-lived President in the history of the modern Italian Republic (post-second world war democratic era).

He was the **first** and the **only President** in **Italy** to be **re-elected to the office**.

12. Veteran Malayalam film director Kulakkattil Geevarghese (K.G.) George has passed away at an old age home in Kakkanad on the outskirts of Kochi, Kerala. He was born on 24 May 1946 in Thiruvalla, Kerala.

He made his debut with **Swapnadanam (1975)** which **won the National Film Award for Best Feature Film** in **Malayalam**.

His well-known films include **Ulkkadal (1979), Mela (1980), Yavanika (1982), Lekhayude Maranam Oru Flashback (1983), Adaminte Vaariyellu (1983), Panchavadi Palam (1984), Irakal (1986), and Mattoral (1988)**. He was a recipient of **9 Kerala State Film Awards** for his various films.

13. Mankombu Sambasivan Swaminathan (M.S. Swaminathan), legendary agricultural scientist and Father of India's 'Green Revolution,' has passed away at the age of 98 in Chennai, Tamil Nadu.

He was **born** on **7th August 1925** in **Kumbakonam, Thanjavur district** of **Tamil Nadu**.

He played a **crucial role** in **developing high-yielding varieties of paddy (wheat and rice)** that helped **ensure India's low-income farmers produce more yield**.

The **United Nations Environment Programme (UNEP)** has called him "**the Father of Economic Ecology**."

He was **nominated** to the **Parliament of India** for one **term** between **2007 and 2013**.

He served as the **Director General** of **Indian Council of Agricultural Research** and later **International Rice Research Institute**.

He also served as the **Principal Secretary** of the **Ministry of Agriculture** in 1979.

Awards:

- Padma Shri (1967)
- Ramon Magsaysay Award (1971)
- Padma Bhushan (1972)
- Albert Einstein World Science Award (1986)
- World Food Prize (1987)
- Padma Vibhushan (1989)
- He is also the recipient of the **H K Firodia award**, the **Lal Bahadur Shastri National Award** and the **Indira Gandhi Prize**.





Days and Themes

1st September - National Nutrition Week

- "Man is What He Eats" - Lucretius
- Every year, September 1 to September 7 is observed as National Nutrition Week or Rashtriya Poshan Maah
- It aims to emphasise the importance of a nutritious diet for the overall development of physical and mental health
- National Nutrition Week was first observed in 1975 by the American Dietetic Association, now it observed all over the world
- It was first observed in India in 1982
- According to UNICEF, the theme of Nutrition Month 2023 is "Healthy Diet Gaining Affordable for All."

2nd September - World Coconut Day

- The day first commemorated in the year 1969 marks the foundation of the Asian Pacific Coconut Community (APCC). It aimed to promote coconut sustainable coconut farming across the Asia-Pacific region.
- The theme of World Coconut Day 2023 is "Sustaining Coconut Sector for the Present and Future Generation."
- Indonesia is the world's largest producer of coconuts. Philippines ranks second, and India is the third-largest producer of coconuts.
- Karnataka produces 4,210.87 metric tonnes annually.
- Tamil Nadu: 3,751.26 MT.
- Kerala: 3,307.78 MT.
- Andhra Pradesh: 1,127.27 MT.
- West Bengal: 278.73 MT.
- Orissa: 273.32 MT.

2nd September- Aditya L-1 Mission Launch

- Aditya L1 mission is India's first solar mission. It will be **launched on today September 2, 2023 at 11:50 AM**, by the **Indian Space Research Organisation (ISRO)** using the PSLV-C57 rocket Aditya L-1 will carry seven payloads which are: **VELC, SUIT, SoLEXS, HEL10S, ASPEX, PAPA**, and Advanced Tri-axial High-Resolution Digital Magnetometers.
- Aditya L1 The mission is set to launch on 2 September 2023 at 11:50 AM IST from Sriharikota.

- The spacecraft will study the outer layer of the sun (Corona).
- Aditya L-1 is a spacecraft that will be placed in a halo orbit around the Sun-Earth Lagrange point L1, which is located about 1.5 million kilometres from Earth.
- Aditya L-1 will carry seven payloads which are: VELC, SUIT, SoLEXS, HEL10S, ASPEX, PAPA, and Advanced Tri-axial High-Resolution Digital Magnetometers.

5th September - International Day of Charity

- The date of **5 September** was chosen in order to **commemorate the anniversary of the passing away of Mother Teresa of Calcutta**, who received the **Nobel Peace Prize in 1979**
- Mother Teresa, the renowned nun and missionary, was born Agnes Gonxha Bojaxhiu in 1910. In 1928 she went to India, where she devoted herself to helping the destitute. In 1948 she became an Indian citizen and founded the order of Missionaries of Charity in Kolkata (Calcutta) in 1950, which became noted for its work among the poor and the dying in that city.
- **5 September**. It was declared by the **United Nations General Assembly** in 2012. The prime purpose of the International Day of **Charity** is to **raise awareness** and provide a common platform for charity related activities all over the world for individuals, charitable, **philanthropic** and volunteer organizations for their own purposes on the local, national, regional and international level.

5th September - Teachers' Day

- The day commemorates the birth anniversary of the first Vice-President and second President of India, **Dr. S Radhakrishnan**. It honours and appreciates the teachers and educators who have made endless contributions to shaping young minds.
- The **first time in the year 1962** in India
- **About Sarvapalli Radhakrishnan**
- Sarvepalli Radhakrishnan was born on September 05, 1888, in a small village in Tamil Nadu. He completed his schooling at Christians Missionary Society High School and went on to pursue his graduation from Voorhees College. Thereafter, he pursued his MA and Philosophy from the University of Madras. He was a brilliant student and was awarded prestigious scholarships





throughout his academic journey. In 1918, he started his teaching career as a professor at the Presidency College in Chennai. He later served as the Vice-Chancellor of Andhra University and Banaras Hindu University. In 1946, he was appointed as the Ambassador of India to the Soviet Union. He served as India's Vice President from 1952 to 1962 and as the President of India from 1962 to 1967. Apart from being an academician, Radhakrishnan was also a renowned philosopher. He wrote several books on Hindu philosophy and religion.

8th September - International Literacy Day

- **International Literacy Day** is celebrated on **September 8** every year to promote the importance of literacy for dignity and human rights, and a literate and sustainable society. The day is celebrated by the **United Nations Educational, Scientific and Cultural Organisation (UNESCO)** at the global, regional, country, and local levels across the world.
- The theme '**Promoting literacy for a world in transition: Building the foundation for sustainable and peaceful societies**'.
- UNESCO estimates that there are more than 770 million people who are considered illiterate across the world. International Literacy Day was first celebrated in **1967**. The purpose of this day is to emphasise the value of literacy to people, communities, and society as literacy is the path to a well-educated and efficient society.

8th September - World Physical Therapy Day

- **World Physical Therapy Day** recognises and celebrates the significant contributions of physical therapists and physiotherapists in promoting health and well-being.
- "**Arthritis**" is the theme for World Physical Therapy Day 2023. Rheumatoid arthritis and axial spondylarthritis are two types of inflammatory arthritis that will be highlighted on this day. The theme of last year's World Physical Therapy Day was osteoarthritis.
- The World Confederation for Physical Therapy founded World Physical Therapy Day, commonly known as World PT Day, in **1996**, more than two decades ago. The reason that September 8 has been chosen as the anniversary is because it was on that day, back in 1951, when the World Confederation was first established. The group is currently referred to as World Physiotherapy

10th September - World Suicide Prevention Day (WSPD)

- The theme is '**Creating Hope Through Action**.' According to the World Health Organization (WHO), "It is estimated that there are currently more than 700 000 suicides per year worldwide."
- International Association for Suicide Prevention with the **World Health Organization (WHO)** established **World Suicide Prevention Day** to be celebrated every year on **September 10**. The declaration came in 2003 and since then, September 10 has been observed to raise awareness about prevention of suicides.

10th September - Grandparents' Day

- In 1973, Senator Jennings Randolph proposed the idea of making Grandparents' Day a national holiday. In 1978, President Jimmy Carter passed the declaration for celebrating Grandparents' Day on the first Sunday after Labour Day. On September 10, 1978, the first Grandparents' Day was celebrated.
- '**Grandparents' Day** in India is observed on the first Sunday of September each year. This year it will be celebrated on September 10.

Atal Pension Yojana

- The **Atal Pension Yojana (APY)** was launched on **09.05.2015** to create a universal social security system for all Indians, especially the poor, the under-privileged and the workers in the unorganised sector. APY is administered by Pension Fund Regulatory and Development Authority (PFRDA).
- APY is open to all bank account holders in the age group of 18 to 40 years and the contributions differ, based on pension amount chosen.
- Provided that from 1st October, 2022, any citizen who is or has been an income-tax payer, shall not be eligible to join APY
- Subscribers would receive the guaranteed minimum monthly pension of Rs. 1000 or Rs. 2000 or Rs. 3000 or Rs. 4000 or Rs. 5000 at the age of 60 years.
- The monthly pension would be available to the subscriber, and after him to his spouse and after their death, the pension corpus, as accumulated at age 60 of the subscriber, would be returned to the nominee of the subscriber.





11th September - National Forest Martyrs Day

- The origins of **National Forest Martyrs Day** date back to 1970, with the tragic event known as the Khejarli massacre that occurred in the Marwar Kingdom of India. This historical incident was sparked by Maharaja Abhai Singh of Rajasthan's order to fell trees in the Bishnoi village of Khejarli, a decision vehemently opposed by the Bishnoi community.
- Tragically, **363 Bishnois lost their lives in this effort.**
- In 2013, recognising the significance of this historical event, the Ministry of Environment declared September 11, the day of the Khejarli massacre, as National Forest Martyrs Day.

9th September - World First Aid Day

- **World First Aid Day** is observed annually on the second Saturday of every September to create awareness around the role of first aid in saving lives. This year the day is being celebrated on September 9 and its theme is '**First Aid in the Digital World**' which promotes utilisation of digital tools and its resources that aid in the provision of first aid education.
- First aid plays a crucial role in emergency medical situations and can prove to be lifesaving in case of heart attacks, seizures, strokes, road accidents etc. It could be a set of life-saving techniques or basic medicines for certain illnesses, bandages, pain killers, or ointments.

13th September- International Chocolate Day

- There is **International Chocolate Day** on September 13, **World Chocolate Day** on July 7, and **two National Chocolate Days** on October 28 and December 28
- In 1780 the United States built its first factory to make and distribute the new chocolate drink. However, it was not until 1842 that chocolate bars began to be produced by Cadbury in England.
- Milk chocolate was invented in Switzerland in 1875. This inspired a young Milton S. Hershey to manufacture and sell his milk chocolates. Thus, Hershey's Chocolate Company was founded, and the first Hershey milk bar was produced in 1900. The famous Hershey's Kiss was invented in 1907.
- Americans consume an extraordinary 3 billion pounds of chocolate every year.

14th September - Hindi Diwas

भारत की आधिकारिक भाषा के रूप में हिंदी को अपनाने के उपलक्ष्य में हर साल 14 सितंबर को हिंदी दिवस मनाया जाता है। हिंदी दिवस की तारीख इसलिए चुनी गई क्योंकि इस दिन 1949 में भारत की संविधान सभा ने देवनागरी लिपी में लिखी हिंदी को भारत गणराज्य की आधिकारिक भाषाओं में से एक के रूप में अपनाया था

- **Hindi Diwas** is celebrated on **14th September every year to commemorate the adoption of Hindi as the official language of India.** The date for Hindi Diwas was chosen because on this day in 1949, the Constituent Assembly of India adopted Hindi written in Devanagari script as one of the official languages of the Republic of India.

15th September - International Day of Democracy

- The **International Day of Democracy**, celebrated on **September 15th** each year, is a global observance that underscores the importance of democracy as a fundamental human right and a cornerstone of good governance and peace. Established in 2007 by a resolution passed by the **United Nations General Assembly (UNGA).**
- The theme for the International Day of Democracy in 2023 is "**Empowering the next generation.**"
- The roots of the International Day of Democracy can be traced back to the Universal Declaration on Democracy, adopted on **September 15, 1997, by the Inter-Parliamentary Union (IPU)**, an international organization of national parliaments.

18th September - World Bamboo Day

- **World Bamboo Day** was recognized by the World Bamboo Organization in the year of **2009.**
- World Bamboo Day was founded by **Kamesh Salam** who was the former president of the World Bamboo Organization. The World Bamboo Organization Headquarters was located in Antwerp, Belgium.
- The **8th World Bamboo Congress** was held in Bangkok on **18 September 2009.** So on this day, the World Bamboo Organization declared that every year the 18th of September is observed as World Bamboo Day.





21st September - International Day of Peace (UN)

- Each year on **21 September**, the world comes together to observe the **International Day of Peace (IDP)**. This day, established by the United Nations (UN), serves as a reminder of our commitment to peace, non-violence, and conflict resolution.
- The theme for the 2023 International Day of Peace is **"Actions for Peace: Our Ambition for the #GlobalGoals"**.
- The International Day of Peace dates back to the United Nations General Assembly passing Resolution 36/67 on **September 30, 1981**. This resolution called for a global ceasefire and the cessation of all hostilities on that day. Subsequently, the third Tuesday of September each year was declared as the International Day of Peace. The first official observance took place on September 21, 1982, and later in 2001, this date was officially established as September 21, marking a significant step toward promoting peace and raising awareness about the importance of peacekeeping efforts worldwide.

21st September - World Alzheimer's Day

- 2023, World Alzheimer's Day theme is **"Never too early, never too late"** **"World Alzheimer's Day"** was introduced on **21st September 1994 in Edinburgh, on the occasion of the 10th anniversary of Alzheimer's Disease International (ADI)**. Alzheimer's Disease International (ADI) is an organisation founded in 1984 with the aim to support and guide Alzheimer's disease patients and their families.
- The disease got its name from **"Alois Alzheimer"**, a German psychiatrist who first discovered this disorder while treating a lady in 1901.
- According to ADI, 13.5 crore people worldwide will be living with dementia by 2050.

22nd September - World Rhino Day

- **World Rhino Day** was commemorated for the first time in 2010, organized by the World

Wildlife Fund. The event was observed in South Africa. The WWF South Africa has initiated great collaborations with other international organizations to raise awareness regarding the challenges faced by endangered Rhino species throughout the world.

• **The five species of the rhinoceros are:**

- Javan Rhino
- Sumatran Rhino
- Black Rhino
- Greater One-horned Rhino
- White Rhino

27th September - World Tourism Day

- The **first World Tourism Day** was held in 1980
- The World Tourism Organisation (UNWTO) started World Tourism Day in 1979. The celebrations for the same officially began in 1980. It is celebrated on 27 September every year because the date marks the anniversary of the adoption of the Statutes of UNWTO. In 1997, UNWTO decided that the day would be celebrated in different host countries each year.

28th September - World Rabies Day

- **World Rabies Day (WDR)**, observed every **September 28**, serves as a global initiative to raise awareness about rabies, a deadly zoonotic disease that claims the lives of thousands of people each year. Established by the **Global Alliance for Rabies Control (GARC)** and recognized by the **World Health Organization (WHO)**, this day aims to promote efforts to combat rabies and highlight the importance of prevention. In this article, we delve into the significance of World Rabies Day, its theme for 2023, and the global fight against this relentless disease.
- This year's theme, **"All for 1, One Health for All,"** underscores the need for a collaborative, intersectoral, and multidisciplinary approach to combat rabies effectively. The inaugural World Rabies Day campaign occurred in 2007





Government Schemes

Himachal CM Sukhu launches SABAL Yojna to empower specially-abled children

- **Himachal Pradesh CM Sukhvinder Singh Sukhu** launched the **Mukhya Mantri Sporting Abilities, Rebuilding Aspirations and Livelihood Scheme (SABAL)**.
- **Objective:** To take care of specially-abled children in around 400 schools across Hamirpur, Solan, and Shimla districts.
- **Aim:** To improve the lives of specially-abled children in the state.
- The initiative focuses on providing essential facilities and opportunities for them, a statement issued here said.

TN govt to launch scheme granting monthly aid to over 1 crore women

- The **Tamil Nadu government** is all set to launch the largest social welfare initiative, the **Kalaingar Magalir Urimai Thogai Thittam**, whereby monthly **financial assistance of Rs 1,000** will be provided to 1.06 crore eligible **women families**.
- The sum will be directly transferred into the bank accounts of beneficiaries and they will be given ATM cards to withdraw the amount.
- The government will start disbursing the money under the scheme from September 15.

Cabinet approved the expansion of Ujjwala Yojana

- The **Cabinet approved** the expansion of the **Pradhan Mantri Ujjwala Yojana (PMUY) allocating 7,500,000 new LPG connections over a three-year period until the FY26**.
- Costing Rs 1,650 crore, this expansion will elevate the total number of PMUY beneficiaries to 103.5 million.
- The government announced this extension after reducing the price of cooking gas by Rs 200 across all markets last month.
- Data indicate that LPG penetration reached 99.9 per cent in 2022
- **Ujjwala Scheme stands for Pradhan Mantri Ujjwala Yojana (PMUY)**. The Ujjwala Scheme is a government scheme under the Ministry of Petroleum & Natural Gas to distribute LPG cylinders to women from Below the Poverty Line (BPL). The aim of PM Ujjwala Yojana is to provide

alternate clean fuel to prevent health issues associated with burning unhealthy fuel.

- The Pradhan Mantri Ujjwala Yojana was launched in August 2016. Under the Ujjwala Scheme, the Center provides qualified individuals with a **deposit-free LPG connection** and financial support in the amount of Rs 1,600 per connection.

State Health Minister launches "Mission Intensified IndraDhanush" 5.0

- **Punjab state Health Minister Balbir Singh** launched "**Mission Intensified Indra Dhanush**" 5.0.
- **Aim:** To provide vaccination against 12 Vaccine-Preventable Diseases (VPD) i.e. diphtheria, Whooping cough, tetanus, polio, tuberculosis, hepatitis B, meningitis and pneumonia.
- The main purpose of the launch of this mission is to cover those **pregnant women** who are partially **vaccinated or unvaccinated** as well as children left out and drop out in the age group of **0-5 years**

PM Vishwakarma Scheme

This is a **central sector scheme launched by MoMSME (Ministry of Micro, Small and Medium Enterprises), to provide end-to-end support to artisans and craftspeople**, which offers services like market linkage support, skill training, incentive for digital transactions to artisans and craftspeople engaged in specified trades.

The Scheme covers artisans and craftspeople engaged in **18 trades**, viz.(i) Carpenter (Suthar/Badhai); (ii) Boat Maker; (iii) Armourer; (iv) Blacksmith (Lohar); (v) Hammer and Tool Kit Maker; (vi) Locksmith; (vii) Goldsmith (Sonar); (viii) Potter (Kumhaar); (ix) Sculptor (Moortikar, stone carver), Stone breaker; (x) Cobbler (Charmkar)/ Shoemsmith/Footwear artisan; (xi) Mason (Rajmistri); (xii) Basket/Mat/Broom Maker/Coir Weaver; (xiii) Doll & Toy Maker (Traditional); (xiv) Barber (Naai); (xv) Garland maker (Malakaar); (xvi) Washerman (Dhobi); (xvii) Tailor (Darzi); and (xviii) Fishing Net Maker.

The Scheme envisages provisioning of the **following benefits** to the artisans and crafts persons:

- (i) **Recognition:** Recognition of artisans and craftspeople through PM Vishwakarma certificate and ID card.



(ii) Skill Upgradation: Basic Training of 5-7 days and Advanced Training of 15 days or more, with a stipend of Rs. 500 per day;

(iii) Toolkit Incentive: A toolkit incentive of upto Rs. 15,000 in the form of e-vouchers at the beginning of Basic Skill Training.

(iv) Credit Support: Collateral free 'Enterprise Development Loans' of upto Rs. 3 lakh in two tranches of Rs. 1 lakh and Rs. 2 lakh with tenures of 18 months and 30 months, respectively, at a concessional rate of interest fixed at 5%, with Government of India subvention to the extent of 8%. Beneficiaries who have completed Basic Training will be eligible to avail the first tranche of credit support of upto Rs. 1 lakh. The second loan tranche will be available to beneficiaries who have availed the 1st tranche and maintained a standard loan account and have adopted digital transactions in their business or have undergone Advanced Training.

(v) Incentive for Digital Transaction: An amount of Re. 1 per digital transaction, upto maximum 100 transactions monthly will be credited to the beneficiary's account for each digital pay-out or receipt.

(vi) Marketing Support: Marketing support will be provided to the artisans and craftspeople in the form of quality certification, branding, on boarding on e-

commerce platforms such as GeM, advertising, publicity and other marketing activities to improve linkage to value chain.

Eligibility

- Any self-employed artisan or craftsman working with hands and tools in one of the foregoing family-based traditional trades in an unorganized sector is qualified.
- The recipient must be 18 to register.
- The recipient must be in the relevant trade and not have received any other government loans.

Chhattisgarh gov launches own housing scheme for state's homeless families

- The **Chhattisgarh government** announced 47,000 odd poor people in the state's rural areas will get houses in **the first phase of the Mukhyamantri Gramin Awasi Yojana**.
- The survey of 59.79 lakh families was conducted in April 2023 and its update went on until May, according to which **10,76,545 families were found living in kutcha houses**.
- This comes after the Pradhan Mantri Awas Yojana was to be implemented by the Chhattisgarh government along with the Centre in 2021.

SBI PO-2022
CONGRATULATIONS
NOTABLE NINE WINNERS

Mahesh Landge	Mauli Navale	Sumit Yadav
Ashish Wankhade	Shreyash Jadhav	Ravindra Jain
Vivek Mahajan	Manish Meshram	Santosh Shirke

WINNER INSTITUTE
India's Best Banking Institute

SBI PO Prelims (Memory Based Paper)

Directions (1-2): Two columns are given in each question and each column has three phrases. Choose the most suitable pair of phrases, which makes a grammatically correct and contextually coherent statement.

Q1. COLUMN A

A. The regulator did not wait for sufficient safety and efficacy data to be collected

B. If there is already some degree of apprehension about the safety and efficacy of COVID-19 vaccines,

C. If the answers to those questions are affirmative, then

COLUMN B

D. the opaque nature of the approval process has done little to mitigate such concerns.

E. and did not share information about the clinical trials before granting approval.

F. made assumptions about increasing rates of technological progress is very reasonable.

(a) B-D (b) A-E & B-D

(c) C-D & B-F (d) A-E & C-F

(e) A-E, B-D & B-F

Q2. COLUMN A

A. These regulatory bodies and committees have remained silent

B. More than being a scientific methodology,

C. The coercive attempt to falsify a study participant's claims and intimidate him or her.

COLUMN B

D. violates the agreed upon rules of clinical trials

E. clinical trials are a method of human cooperation

F. the impression that they are not independent

(a) B-D (b) A-E & B-D

(c) C-D & B-F (d) A-E & C-F

(e) B-E & C-D

Directions (3-6): In each of the questions given below a sentence is given in which a word is highlighted. Each sentence is then followed by three words. Choose the word(s) that can replace the given word in bold to make a grammatically and contextually

meaningful sentence as your answer. If none of the words can replace the highlighted word then choose "None can replace" as the correct choice.

Q3. There is a vending machine on the platform that **dispenses** snacks.

(i) Disburses (ii) Squander (iii) Distributes

(a) Only (i) (b) Both (I) &(iii)

(c) None can replace (d) Only (ii)

(e) Only (iii)

Q4. India and Japan have devised a **mechanism** for cooperation in the steel industry at the joint secretary level.

(i) System (ii) Method (iii) tools

(a) Only (i) (b) Both (I) &(iii)

(c) Both (i) & (ii) (d) Only (ii)

(e) None can replace

Q5. Your business premises which **qualify** for business asset taper relief have become too cramped.

(i) Hamper (ii) Measured (iii) Inclined

(a) None can replace (b) Both (I) &(iii)

(c) Both (i) & (ii) (d) Only (ii)

(e) Only (iii)

Q6. The misuse of the Governor's office to undermine duly elected State governments is a particularly mischievous **disruption** of federalism.

(i) Disturbance

(ii) Obstruction

(iii) Relevant

(a) None can replace (b) Both (I) & (iii)

(c) Both (i) & (ii) (d) Only (ii)

(e) Only (iii)

Directions (7-9): In each of the following sentences, parts of the sentence are left blank. Beneath each sentence, five different ways of completing the sentence are indicated. Choose the best alternative among the given options.



Q7. Police _____ Notorious Gangster after relentless chase that _____ for 3 weeks.

- (a) Arrest, reigned (b) Nabbed, lasted
(c) Snatched, persist (d) Contempt, endured
(e) Apprehend, sustain

Q8. Tropical rain forests choked in fog and continuously _____ by mists and down pours are least _____ by fires.

- (a) Rejuvenate, impact
(b) Exhausted, Overwhelm
(c) Drenched, affected
(d) Approach, Influence
(e) Devoured, swayed

Q9. An interview is a good chance to _____ how candidates _____ difficult situations

- (a) Discuss, improved (b) Assess, addressed
(c) Analyze, tackling (d) Evaluate, approach
(e) understand, enhance

Directions (10-12): Improve the bold part in the following sentences, if needed.

Q10. He made himself master of practically every branch of medieval learning, and **has a thoroughly knowledge of** the sources and the bibliography of his subject

- (a) having a thorough knowledge of
(b) has had a thorough knowledge to
(c) Have a thoroughly knowledge for
(d) had a thorough knowledge of
(e) No Correction required

Q11. Gionee **has been found guilty for** intentionally inflicting malware in over 20 million phones by a Chinese court.

- (a) had been found guilty for
(b) has been found guilty of
(c) has been found being guilty with
(d) have found to guilty for
(e) No Correction required

Q12. Many people believe that voluntary bodies as they are today should **not entrusted with** this national responsibility.

- (a) be entrust not with
(b) not be entrust with

- (c) not being entrusted for
(d) not be entrusted with
(e) No Correction required

Directions (13-14): In each of the questions given below, four words have been highlighted which may or may not be at their correct positions. Pick the most suitable option to interchange the words, so that the statement becomes grammatically correct and contextually meaningful.

Q13. The MNM's promise to directly pay women a monthly amount may be **competitive (A)** as a **landscape (B)** to grab attention in an over-crowded, highly **viewed (C)** electoral **strategy (D)**.

- (a) CDAB (b) No rearrangement required
(c) BDCA (d) ADCB (e) CABD

Q14. With the Indian economy gradually **debating (A)** its feet after a historic contraction, economic commentators have **finding (B)** themselves with **viability(C)** the need for fiscal expansion and the **busied (D)** of a "V-shaped recovery".

- (a) CADB (b) ABDC
(c) No rearrangement required
(d) BDAC (e) DBAC

Directions (15-21): Read the following passage carefully and answer the questions given below it. Certain words have been printed in bold to help you locate them, while answering some of the questions.

In some ways we already do: every time we spend our cash we are making an active choice about the companies we support and the practices we **endorse**. Today, when corporations can be more influential than entire states, where we put our pounds is where the power lies. The problem is, so it is difficult to confidently make an informed choice.

Consider this: the retail manufacturing industry is the second most polluting industry on earth, second only to oil. According to Annie Leonard, an expert in overconsumption, only 1% of the materials used to produce our consumer goods

are still in use six months after sale. Somewhere, the value of craftsmanship and of provenance has been lost. Price and speed are trumping value. However, the tide is turning. Increasing awareness around these issues has led to a rise in what is known as conscious consumption, a movement of people who seek out ways to make positive decisions about what to buy and look for a solution to the negative impact consumerism is having on our world.

This is a growing tribe: a third of UK consumers claim to be very concerned about issues regarding the origin of products. A study from YouGov and the Global Poverty Project revealed that 74% of those surveyed would pay an extra 5% for their clothes if there was a guarantee workers were being paid fairly and working in safe conditions. If you're thinking that 5% doesn't sound like a lot, consider the fact that the fashion industry could take a **staggering** 125 million people out of poverty by adding only 1% of its profits to workers' wages.

Issues such as equal pay, environmentally conscious manufacturing processes, prevention of counterfeit goods, human trafficking, responsible farming practices and overproduction of goods are all at the forefront of consumers' minds when making these choices. In an increasingly open, digital world where authenticity is the buzzword of choice, businesses must keep up with growing demands for ethical behaviour and transparency in everything from employee rights and gender discrimination to the supply chain.

In studying for my PhD, I researched product supply chain transparency in depth, looking at technologies to improve information about products and the global network of people and resources that fuel them. I believe technology is the key to dealing with the challenges created by consumerism. Open data, social networks and mobile tech can change the game. Groundbreaking technologies could enable transparency in supply chains, which is why this year I have **(I)** on turning my findings into a social enterprise to empower businesses to take steps to being open.

Q15. Why businesses must keep up with growing demands of ethical behaviour and transparency?

- (a) As the world of business can be opaque and supply chains are murky
- (b) As the value of craftsmanship and of provenance has been lost
- (c) As they want to tackle the huge impact our current production levels having on the world
- (d) As Customers are taking an increasing interest in the ethical practices of those from whom they buy
- (e) None of these

Q18. According to the author how can we tackle the impact of consumerism?

- (a) By using technology in order to increase transparency in supply chains
- (b) By replenishing the resources which were otherwise depleted due to overconsumption
- (c) By increasing the lifespan of the products so as to reduce the consumption.
- (d) By spending extra for the products if there was a guarantee worker were being paid fairly
- (e) None of these

Q19. Which of the following word is most similar in meaning to the word "endorse" as given in the passage?

- (a) Sabotage
- (b) Promote
- (c) Veto
- (d) Deliberate
- (e) Censure

Q20. Which of the following word is most similar in meaning to the word "staggering" as given in the passage?

- (a) Enfeebling
- (b) Common
- (c) Mundane
- (d) Draining
- (e) Confound

Q21. Choose the most suitable word/phrase to fill the given blank (I).

- (a) Persist
- (b) Sustaining
- (c) Ceased
- (d) Resist
- (e) Embarked

Directions (22-26): Rearrange the following six sentences (A), (B), (C), (D), (E) and (F) in the proper sequence to form a meaningful

paragraph and then answer the questions given below.

A. This is partly linked to drop in payment rates, as consumers are struggling to pay their bills amid rising consumption and tight finances.

B. Embracing energy efficiency can be a win-win solution as this can bring down household energy bills and reduce discoms' financial stress

C. The Indian government has sanctioned liquidity relief to help discoms tide over this crisis, but these are just short-term fixes.

D. The rules lay down uniform performance standards for power distribution companies (discoms) and make them liable to compensate consumers in case of violations.

E. The well-intentioned rules come at a time when Indian discoms are struggling to manage their finances.

F. The Power Minister, R.K. Singh, recently announced the Electricity (Rights of Consumers) Rules, 2020.

Q22. What should be the FOURTH sentence after rearrangement?

- (a) F (b) A (c) B
(d) C (e) D

Q23. What should be the THIRD sentence after rearrangement?

- (a) E (b) C (c) A
(d) B (e) F

Q24. What should be the LAST sentence after rearrangement?

- (a) F (b) C (c) B
(d) A (e) D

Q25. What should be the SECOND sentence after rearrangement?

- (a) F (b) B (c) C
(d) D (e) E

Q26. What should be the FIRST sentence after rearrangement?

- (a) F (b) D (c) E
(d) B (e) C

Directions (27-30): In each of the following questions, four sentences are given and you have to choose the one which has some or any grammatical error in it. If all the given four sentences are correct choose option (e) as your choice.

Q27.

(a) The government acknowledged that the Form 27 format was problematic and provided an undertaking to the court to effect appropriate amendments.

(b) Opacity in communication is dangerous when there is high vaccine hesitancy

(c) Hong Kong should no sooner erase its colonial past the Beijing should demolish the Forbidden City

(d) We need to improve the availability and affordability of energy-efficient appliances.

(e) All are correct

Q28.

(a) The growth conundrum that Kantibhai and Sureshbhai plan to solve is perhaps the same which a majority of MSME owners in the country face.

(b) India needs a nationwide consumer awareness campaign on energy efficiency.

(c) Record GST inflows in December augur well, but the economy is still in a flux

(d) The country requires a new political instrument for governability

(e) All are correct

Q29.

(a) The government has significantly weakened the critical duty imposed by the law on patentees/licensees to disclose patent working information

(b) Too much of strong leadership has robbed India of its democratic exuberance and constitutional dynamism.

(c) Core sectors recorded yet another contraction in November, with cement and steel slipping back after a minor uptick.

(d) Many of his pieces have designs incised or in relief, and others are skilful decorated with gold and silver



(e) All are correct

Q30.

(a) The gender gap in the agriculture sector will only widen more with the current farm laws

(b) Journalism focuses on a narrative of gloom that forces many people to avoid news altogether.

(c) Journalism creates a better-informed citizenry, which in turn creates a better collective future

(d) There will possibly be a unanimous rejection of the Republican objections to Joe Biden's electoral votes

(e) All are correct

Direction (31 - 35): Given bar graph shows percentage distribution of total CD's ordered by four shopkeeper (A, B, C & D) and percentage of CD's sold by these four shopkeepers out of total CD's ordered by each. Read the data carefully and answer the questions.

Total CD's ordered by all four shopkeepers together = 600

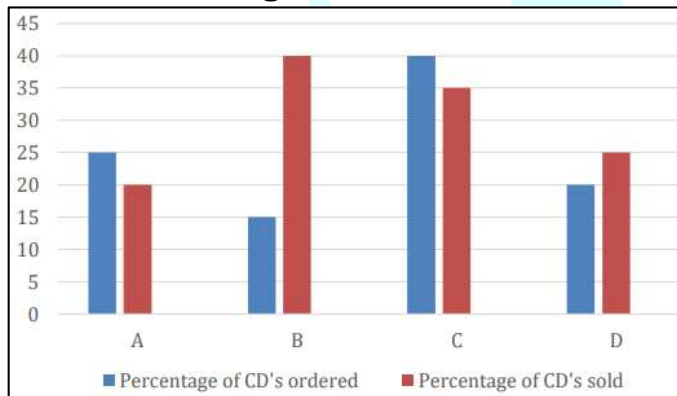

Q31. Total unsold CD's by A & D together are how much more than total sold CD's by C?

- (a) 126 (b) 132 (c) 128
(d) 116 (e) 118

Q32. If total CD's sold by shopkeeper E are 125% more than total CD's sold by B and shopkeeper E sold 27% of total ordered CD's, then find total CD's ordered by E are what percent more than total CD'S ordered by C ?

- (a) 36% (b) 15% (c) 30%
(d) 20% (e) 25%

Q33. Find average number of unsold CD's by B, C & D?

- (a) 120 (b) 100 (c) 80
(d) 110 (e) 72

Q34. Find ratio of total CD's sold by A & D together to total CD's sold by B?

- (a) 5 : 3 (b) 3 : 5 (c) 5 : 4
(d) 5 : 6 (e) 4 : 5

Q35. If total CD's ordered by shopkeeper X is 100% more than total unsold CD's by D and X sold 30% of total ordered CD's, then find unsold CD's by X are what percent of unsold CD's by A?

- (a) 105% (b) 110% (c) 100%
(d) 96% (e) 90%

Directions (36-40): In each question two equations numbered (I) and (II) are given. You should solve both the equations and mark appropriate answer.

- (a) if $x > y$
(b) if $x \geq y$
(c) if $x < y$
(d) if $x \leq y$
(e) if $= y$ or the relationship cannot be established

Q36. I. $x^2 - 7x + 10 = 0$ II. $y^2 - 2y - 3 = 0$

Q37. I. $x^2 - 24x + 143 = 0$ II. $y^2 - 29y + 210 = 0$

Q38. I. $x^2 + 22x + 117 = 0$ II. $y^2 + 23y + 132 = 0$

Q39. I. $2x^2 - 3x - 20 = 0$ II. $2y^2 + 11y + 15 = 0$

Q40. I. $x^2 - 12x + 32 = 0$ II. $y^2 - 20y + 96 = 0$

Q41. A boat travels in upstream. If the speed of boat in upstream is decreased by 40% then it is equal to the speed of current and speed of boat in still water is given as 240 km/hr. Then find upstream speed of boat? (in km/hr).

- (a) 120 (b) 180 (c) 150
(d) 210 (e) 125

Q42. A man invested Rs. X and Rs. 2X at 15% simple interest and at 8% compound interest



(compounding annually) for two years respectively. Difference between simple interest and compound interest received after two years is Rs.820. Find the value of X.

- (a) Rs.25000 (b) Rs.30600
(c) Rs.28600 (d) Rs.22200
(e) Rs.26200

Q43. Length of train A is 400 meters and length of train B is 'x' meters more than train A. If speed of both train A & B is equal and they cross a pole in 16 sec and 24 secs respectively, then in what time train 'B' will cross 400 m long platform.

- (a) 32 sec (b) 40 sec (c) 45 sec
(d) 54 sec (e) 24 sec

Q44. 'A' is 40% less efficient than 'B' who can do the same work in 20% less time than 'C'. If A and B together can complete 80% of work in 12 days, then in how many days 60% of work can be completed by B and C together.

- (a) 2 days (b) 4 days (c) 6 days
(d) 8 days (e) 10 days

Q45. Perimeter of rectangle is equal to the perimeter of square whose area is 400 cm^2 and length of rectangle is 40% more than the side of a square then find the area of rectangle?

- (a) 248 cm^2 (b) 420 cm^2 (c) 356 cm^2
(d) 336 cm^2 (e) 348 cm^2

Q46. A shopkeeper has two articles jeans and shirt. Cost price of a jeans is 32.5% more than cost price of a shirt and cost price of jeans is increased by 30% and it sold in Rs. 4134 at the profit of 25%. If shirt marked up 15% above cost price, then find the marked price of shirt (in Rs.)?

- (a) 2200 (b) 2208 (c) 2280
(d) 2820 (e) 2082

Q47. In first mixture, quantity of milk was 6 lit more than that of water. After adding 40 ltr of second mixture (having ratio of water to milk 3: 5) in the first mixture, ratio of water to milk

in the final mixture becomes 9: 13. Find the total quantity of water in the final mixture.

- (a) 27 ltr (b) 31.5 ltr (c) 36 ltr
(d) 45 ltr (e) None of these

Q48. A and B started a business together with capital of Rs. 8000 and Rs. 10,000 respectively. A left the business after 5 months while B continued. A gets 20% of total profit for managing business and remaining is distributed in ratio of their profit sharing. If after a year, A gets total profit of Rs.2500 then, find the total profit earned by 'A' and 'B' together.

- (a) 10,000 (b) 8,500 (c) 7,500
(d) 6,250 (e) 5,750

Q49. The salary of A man is Rs. 50000 per month from which he spends 20% on rent, 10% of remaining on bills, 20% of further remaining on miscellaneous expenses. From the remaining amount, man gives some money to his wife and rest he invests in mutual funds in the ratio of 5 : 4. Find amount spent on rent is how much less or more than amount invested in mutual funds.

- (a) 2800 Rs. (b) 2400 Rs. (c) 2600 Rs.
(d) 3200 Rs. (e) 3000 Rs.

Q50. A bag has seven red, four white and three green balls while another bag has five red, six yellow and three blue balls. A bag is selected at random and a ball drawn out of it, then Find the probability that the ball drawn is red.

- (a) $\frac{1}{7}$ (b) $\frac{3}{7}$ (c) $\frac{2}{7}$
(d) 1 (e) $\frac{6}{7}$

Direction (51 - 55): Table Given below shows total number of male visitors on four different days to a park and it also shows percentage of female visitors on these four days. Read the data carefully and answer the questions.

Days	Total male visitors	Percentage of female visitors
Sunday	120	76%
Monday	280	30%
Tuesday	500	37.5%
Wednesday	420	40%



Q51. Total female visitors on Sunday & Monday together is how much more or less than total number of female visitors on Tuesday & Wednesday together.

- (a) 160 (b) 140 (c) 120
(d) 100 (e) 80

Q52. Total visitors on Wednesday are what percent more than total number of visitors on Sunday?

- (a) 60% (b) 20% (c) 40%
(d) 80% (e) 50%

Q53. Total number of male visitors on Friday are 25% more than total number of male visitors on Monday, while total number of female visitors on Friday are 40% more than total number of visitors on Tuesday. Find total visitors on Friday?

- (a) 1470 (b) 1050 (c) 1620
(d) 1200 (e) 1170

Q54. Total number of visitors on Wednesday is how much more than total number of female visitors on Sunday and Monday together?

- (a) 300 (b) 200 (c) 250
(d) 350 (e) 150

Q55. If there is one guide for per five visitors on each day, then find total **number** of guides required for all visitors on these four days?

- (a) 240 (b) 480 (c) 220
(d) 440 (e) 460

Direction (56 - 60): Find the wrong number in following number series:

Q56. 5, 18, 34, 54, 79, 110, 158

- (a) 34 (b) 5 (c) 18
(d) 54 (e) 158

Q57. 112, 128, 108, 132, 104, 134, 100

- (a) 112 (b) 128 (c) 134
(d) 108 (e) 100

Q58. 5, 6, 14, 45, 184, 920, 5556

- (a) 5 (b) 6 (c) 14
(d) 920 (e) 45

Q59. 10, 22, 35, 50, 68, 92, 117

- (a) 92 (b) 117 (c) 10
(d) 22 (e) 35

Q60. 64, 34, 36, 56, 114, 287, 860

- (a) 114 (b) 860 (c) 64
(d) 36 (e) 56

Direction (61-65): Read the data carefully and answer the questions.

There are 450 students in a school and there are two sections A & B in the school. There are three streams in each section i.e., Art, Science & Commerce. $\frac{75}{4}$ % of total students in A are in Commerce and $\frac{200}{7}$ % of total students in B are in Science. Sum of total students in Commerce in A & total students in Science in B is 105. $\frac{400}{21}$ % of total students in B are in Commerce and 50% of total students in A are in Art.

Q61. Total students in Art in A is what percent more than total students in Science in B?

- (a) 75% (b) 70% (c) 90%
(d) 100% (e) 110%

Q62. Find the ratio of total students in Commerce in B to total students in Science in A?

- (a) 8 : 15 (b) 8 : 17 (c) 8 : 13
(d) 8 : 11 (e) 8 : 9

Q63. If in other section C, total students are 180 and total student in Science in C are 25% more than total students in Commerce in B, then find total students in Art & Commerce in C is how much less than total students in Art & Commerce in A?

- (a) 55 (b) 60 (c) 65
(d) 45 (e) 35

Q64. Find the average number of students in Science in A & B?

- (a) $\frac{125}{2}$ (b) $\frac{135}{2}$ (c) 120
(d) 130 (e) 145

Q65. If out of total students in Art in A & B, ratio of boys to girl is 5 : 3 and 7 : 4

respectively, then find total boys in Art from both sections?

- (a) 125 (b) 135 (c) 145
(d) 115 (e) 105

Direction (66-70): Study the following information carefully and answer the questions given below:

Eight persons i.e. A, B, C, D, P, Q, R and S are sitting around a rectangular table in such a way that four persons sit on each of the four corner of the table and other four persons sit on the middle of each side. The one who sits at the corner of table faces opposite to center of table and the one who sits at the middle side of table faces towards the center of table. Persons sitting on opposite sides are exactly opposite to each other. Q sits immediate to the right of D. Both R and C are sitting opposite to each other. Only one person sits between A and B, who does not sit near to D. C sits near to Q. Two persons sit between D and S, who faces to the center.

Q66. Who among the following sits 3rd to the right of P?

- (a) A (b) B (c) Q
(d) D (e) None of these

Q67. How many persons sit between P and Q, when counted to the left of P?

- (a) One (b) Two (c) Four
(d) Either (b) or (c) (e) None of these

Q68. Four of the following five are alike in a certain way and hence they form a group. Which one of the following does not belong to that group?

- (a) R (b) D (c) P
(d) C (e) B

Q69. Which of the following is not true regarding P?

- (a) C sits 2nd to the left of P
(b) P sits immediate to the right of B
(c) D sits opposite to P
(d) Two persons sit between P and R, when counted to the left of R
(e) All are true

Q70. What is the position of R with respect to Q?

- (a) 2nd to the right (b) 2nd to the left
(c) 3rd to the left (d) 3rd to the right
(e) None of these

Directions (71-73): Study the information carefully and answer the questions given below.

Eight persons in three generation of the family. K is daughter in law of G. M is father of L, who is daughter-in-law of P. H is brother-in-law of G and only son of F. T is grandson of F. H is unmarried. G is male. M has two child.

Q71. How is M related to G?

- (a) Father (b) Brother
(c) Father-in-law (d) Brother-in-law
(e) None of these

Q72. How is K related to L?

- (a) Daughter (b) Mother-in-law
(c) Daughter-in-law (d) Sister
(e) None of these

Q73. Who among the following is son of M?

- (a) H (b) G (c) T
(d) L (e) None of these

Direction (74-77): Study the following information carefully and answer the questions given below:

In a certain code language

'work just not done' is coded as 'ds gi nj hq'
'work same and equal' is coded as 'gi sw as xz'
'same case just opposite' is coded as 'sw ds ap kl'
'not opposite but equal' is coded as 'mn ap nj as'

Q74. What is the code of 'opposite' as per the given code language?

- (a) ap (b) gi (c) mn
(d) as (e) None of these

Q75. What is the code of 'same' as per the given code language?

- (a) ap (b) sw (c) mn
(d) as (e) None of these

Q76. What is the code of 'case' as per the given code language?

- (a) gi (b) sw (c) kl
(d) as (e) None of these

Q77. What is the code of 'equal work' as per the given code language?

- (a) gi ds (b) sw kl (c) as gi
(d) as sw (e) None of these

Directions (78-82): Study the following information carefully and answer the question given below.

Seven students A, B, D, E, G, H and L have practical exams on different day of the same week starting from Monday to Sunday, but not necessarily in the same order. Only one student has a practical exam on each day.

There are more than three students have practical exam after A. Only one student has practical exam between A and H. There are three students have practical exam between G and B. G has practical exam before H but not immediate before H. There are three students have practical exam between D and E, who does not have practical exam in the last day of week.

Q78. On which of the following day L has practical exam?

- (a) Tuesday (b) Thursday
(c) Saturday (d) Monday (e) None of these

Q79. Who among the following has practical exam on Wednesday?

- (a) A (b) H (c) G
(d) E (e) None of these

Q80. How many students have exam between E and B?

- (a) No one (b) One (c) Two
(d) Three (e) More than three

Q81. Who among the following has practical exam immediate before H?

- (a) E (b) L (c) B
(d) D (e) None of these

Q82. Four of the following five belong to a group in a certain way, find which of the one does not belong to that group?

- (a) A, G (b) H, E (c) L, B
(d) E, A (e) B, D

Directions (83-85): In these questions, relationship between different elements is show in the statements. The statements are followed by conclusions. Study the conclusions based on the given statements and select the appropriate answer:

- (a) If only conclusion I follows.
(b) If only conclusion II follows.
(c) If either conclusion I or II follows
(d) If neither conclusion I nor II follows.
(e) If both conclusions I and II follow.

Q83. Statements: $J=Q>R=V>B=Y>K\geq M$

Conclusion I: $R>Y$ **II:** $J<B$

Q84. Statements: $Q=T<I>X\geq G>P=Z<O$

Conclusion I: $Z\leq I$ **II:** $O>G$

Q85. Statements: $S>F\geq B=D\leq P=E\leq L>Q$

Conclusion I: $E>B$ **II:** $B=E$

Directions (86-88): Study the information carefully and answer the questions given below.

Point P is 8m west of point G. Point G is 16m east of point T. Point H is east of point E. Point E is 5m north-west of point L. Point A is 12m south of point F and point P is midpoint between them. Point L is 8m south of point S. Point H is midpoint between point L and S. Point T is 14m south of point E.

Q86. If Point B is west of point A and south of point S, then what is the distance between point A and point B?

- (a) 13m (b) 7m (c) 6m
(d) 5m (e) None of these

Q87. In which direction point L is with respect to point F?

- (a) South (b) South-east
(c) North-east (d) East



(e) None of these

Q88. What is the distance between point E and point H?

- (a) 7m (b) 3m (c) 4m
(d) 5m (e) None of these

Q89. How many pairs of letters are there in the word "SPARKLE" which has as many letters between them as we have in the English alphabetical series (from both forward and backward direction)?

- (a) One (b) None (c) Two
(d) Three (e) More than three

Q90. Which of the following is second letter from the left end of the meaningful word formed by the 1st, 3rd, 5th, and 6th letter of the word "DRAWER" if more than one word is formed mark X as your answer. If no such word is formed mark Y as your answer?

- (a) R (b) D (c) E
(d) X (e) Y

Direction (91-95): Study the following information carefully and answer the questions given below:

A certain number of persons are sitting in a row facing to the north. There is one person sits between N and M and one of them sit at the extreme end of the row. There are three persons sit between N and C. L sits 2nd to the left of C. There are six persons sit between C and B, who sits 3rd from one of the end. B sits 2nd to the left of R, who does not sit at the extreme end. There are four persons sit between O and N. More than three persons sit between M and O. There are two persons sit between K and R.

Q91. How many persons are sitting in the row?

- (a) 12 (b) 15 (c) 18
(d) 17 (e) 16

Q92. How many persons sit between R and C?

- (a) None (b) Four (c) Six
(d) Five (e) Seven

Q93. What is the position of K with respect to B?

- (a) Immediate to the right (b) 2nd to the left
(c) Immediate to the left (d) 2nd to the right
(e) 3rd to the left

Q94. The number of persons sit to the left of L is same as the number of persons sit to the right of ___?

- (a) N (b) O (c) C
(d) K (e) None of these

Q95. If T sits between B and R, then how many persons sit between T and K?

- (a) None (b) One (c) Two
(d) Three (e) None of these

Direction (96-100): Study the following information carefully and answer the questions given below:

Eight boxes i.e. M, N, O, P, Q, R, S and T are placed one above the another but not necessarily in the same order.

Three boxes are placed between M and T. M is placed either at the top most or bottom most position. Box O is placed just above to the box N. Box S is placed just below to the box T. There are two boxes placed between R and S. Not more than two boxes placed between M and R. More than three boxes placed between O and P.

Q96. Which of the following box is placed third from the bottom?

- (a) S (b) Q (c) O
(d) R (e) None of these

Q97. How many boxes are placed between O and Q?

- (a) None (b) One (c) Four
(d) Two (e) None of these

Q98. The number of boxes placed between P and S is same as the number of boxes placed between ___ and R?

- (a) M (b) Q (c) N
(d) T (e) O



Q99. The number of boxes placed above of the box O is same as the number of boxes placed below to the box?

- (a) R (b) Q (c) P
(d) T (e) None of these

Q100. Four of the following five are alike in a certain way and hence they form a group. Which one of the following does not belong to that group?

- (a) M and Q (b) P and T
(c) R and S (d) Q and O
(e) N and Q



IBPS / PO / SO / CLERK SBI CLERK - 2023

Wonderful Winners

 Chetan Morkar Union Bank of India, PO	 Pranjal Dholane Punjab National Bank, PO	 Rashika Bhattacharya Union Bank of India, PO	 Ravindra Patil SBI, Branch Executive Officer	 Dringshal Niran Indian Bank, PO	 Saurabh Dorge Bank of Maharashtra, PO	 Sheetal Thakur Union Bank of India, PO	 Akehay Patil Bank of Maharashtra, PO	 Akshitesh Shinde Bank of India, PO	 Ajay Garole Indian Bank, PO
 Dhanraj Kawale Bank of Maharashtra, PO	 Pradip Khandagale Citi Bank, PO	 Megha Nalkande Punjab National Bank, PO	 Suraj Sarang Bank of Maharashtra, PO	 Sanyuka Kamewar Central Bank of India, PO	 Rushikesh Suryawanshi SBI, Branch, PO	 Aniket Gangurde Bank of Maharashtra, PO	 Poornima Wankhede Bank of Maharashtra, PO	 Rishikesh Khaire Union Bank of India, PO	 Vishakha Pathak Bank of India, PO
 Shriyesh Beladkar Union Bank of India, PO	 Deepak Dhangar Bank of India, PO	 Shreyansh Jain Canara Bank, PO	 Saurabh Borude Punjab National Bank, PO	 Chetan Kuwar Union Bank of India, PO	 Priyanka Shinde Bank of Maharashtra, PO	 Ashitesh Rane Indian Bank, PO	 Jay Dorle Canara Bank, PO	 Ashish Suryawanshi Canara Bank, PO	 Nanjan Pawara Canara Bank, PO
 Sourabh Choudhary Citi Bank of India, PO	 Anurag Mishra Ubu Bank, PO	 Srushti Khatkale Bank of India, PO	 Prasanjit Sakhre Bank of Maharashtra, PO	 Vishal Patil Bank of Maharashtra, PO	 Sahil Bulkunde SBI, Union Bank, PO	 Ankita Kawale Union Bank of India, PO	 Rupesh Harsh Canara Bank, PO	 Chandrashekar Pang Indian Bank, PO	
 Nikhil Kukde Ubu Bank of India, PO	 Divyanshu Lokhande Union Bank of India, PO	 Sandip Vhate Central Bank of India, SO	 Vishal Mohite Union Bank of India, SO	 Ravindra Patil Bank of Maharashtra, Clerk	 Vaibhav Rathod Bank of India, Clerk	 Chetan Morkar Bank of India, Clerk	 Rishikesh Khaire SBI, Bank of India, Clerk	 Saurabh Borude Punjab National Bank, Clerk	
 Priyanka Shinde SBI, Clerk	 Sanket Hujjuti SBI, Clerk	 Vikas Yadav SBI, Clerk	 Chetan Kuwar SBI, Clerk	 Vaibhav Rathod SBI, Clerk	 Ajay Garole SBI, Clerk	 Aniket Gangurde SBI, Clerk	 Sujata Kamtha SBI, Clerk	 Reshma Bhunde SBI, Clerk	



WINNER INSTITUTE

India's Best Banking Institute

99 22 41 6666
80 87 167 666

SBI PO Prelims (Memory Based Paper) Solutions

Q.1. B	Q.11. B	Q.21. E	Q.31. A	Q.41. C	Q.51. E	Q.61. D	Q.71. C	Q.81. A	Q.91. E
Q.2. E	Q.12. D	Q.22. B	Q.32. E	Q.42. A	Q.52. C	Q.62. A	Q.72. C	Q.82. E	Q.92. B
Q.3. B	Q.13. A	Q.23. A	Q.33. B	Q.43. B	Q.53. A	Q.63. E	Q.73. A	Q.83. A	Q.93. C
Q.4. C	Q.14. D	Q.24. C	Q.34. A	Q.44. D	Q.54. B	Q.64. B	Q.74. A	Q.84. D	Q.94. B
Q.5. A	Q.15. D	Q.25. D	Q.35. A	Q.45. D	Q.55. B	Q.65. C	Q.75. B	Q.85. C	Q.95. B
Q.6. C	Q.16. A	Q.26. A	Q.36. E	Q.46. B	Q.56. E	Q.66. A	Q.76. C	Q.86. D	Q.96. A
Q.7. B	Q.17. D	Q.27. C	Q.37. C	Q.47. C	Q.57. C	Q.67. B	Q.77. C	Q.87. E	Q.97. D
Q.8. C	Q.18. A	Q.28. A	Q.38. E	Q.48. D	Q.58. D	Q.68. E	Q.78. C	Q.88. B	Q.98. E
Q.9. D	Q.19. B	Q.29. D	Q.39. B	Q.49. A	Q.59. A	Q.69. D	Q.79. D	Q.89. E	Q.99. C
Q.10. D	Q.20. E	Q.30. E	Q.40. D	Q.50. B	Q.60. B	Q.70. D	Q.80. B	Q.90. D	Q.100. E



RBI SELECTIONS

RBI GRADE 'B' OFFICER









Pradeep Ghule Srinjoy Guha Pratik Korde Nishant Yadav Vivek Mittal Shivangi Malvia Rashmi Priya

RBI ASSISTANT









Shailesh Bolegave Shafiya Tamboli Pooja Markwar Sachin Maher Dhiraj Sarwe Vijay Kadam Naveen Jha

RBI ATTENDENT









Rahul Jambhulkar Rushikesh Varpe Snehal Dongre Tushar Deshmukh Akshay Pawar Shivani Pujari Karan Sandekar Dhanshree Shide









Shubham Burade Yuvraj Giri Bhagwat Pansare Shweta Gajbiye Siddharth Lokhande Sandip Nathe Snehal Phonde Janardhan Lanje



WINNER INSTITUTE

India's Best Banking Institute



99 22 41 6666

80 87 167 666

IBPS Clerk Mains (Memory Based Paper)

Directions (1-7): Read the following passage and answer the questions given below. Some words are highlighted to help you answer some of the questions.

Air pollution harms human health and the environment. In Europe, emissions of many air pollutants have decreased substantially over the past decades, resulting in improved air quality across the region. However, air pollutant concentrations are still too high, and air quality problems **persist**. A significant proportion of Europe's population lives in areas, especially cities, where exceedances of air quality standards occur: ozone, nitrogen dioxide and particulate matter (PM) pollution pose serious health risks. Several countries have exceeded one or more of their 2010 emission limits for four important air pollutants. Reducing air pollution therefore remains important. Air pollution is a local, pan-European and hemispheric issue. Air pollutants released in one country may be transported in the atmosphere, contributing to or resulting in poor air quality elsewhere.

Particulate matter, nitrogen dioxide and ground-level ozone are now generally recognized as the three pollutants that most significantly affect human health. Long-term and peak exposures to these pollutants range in severity of impact, from impairing the respiratory system to premature death. Around 90 % of city dwellers in Europe are exposed to pollutants at concentrations higher than the air quality levels deemed harmful to health. Air pollution is causing damage to human health and ecosystems. Large parts of the population do not live in a healthy environment, according to current standards. To get on a sustainable path, Europe will have to be ambitious and go beyond current legislation. Acidification was substantially reduced between 1990 and 2010 in Europe's sensitive ecosystem areas that were subjected to acid deposition of excess sulfur and nitrogen compounds. The EU's long-term objective is to achieve levels of air quality that do not result in unacceptable impacts

on, and risks to, human health and the environment.

Crop damage is caused by exposure to high ozone concentrations. Most agricultural crops are exposed to ozone levels that exceed the EU's long-term objective intended to protect vegetation. This notably includes a significant proportion of agricultural areas, particularly in southern, central and eastern Europe. Air quality has not always improved in line with the general decrease of **anthropogenic emissions** of air pollutants. There is not always a clear linear relationship between decreasing emissions and the concentrations of air pollutants observed in the air. Targeted efforts to reduce emissions are therefore still required to further protect human health and the environment in Europe. The European Environment Agency (EEA) is the European Union's air pollution data center; it supports the implementation of EU legislation linked to air emissions and air quality. The EEA also contributes to the evaluation of EU air pollution policies and to the development of long-term strategies to improve air quality in Europe.

Q1. What, according to the author, is/are driving and adding to poor air quality in various parts of the world?

- (a) Pollutants that are exposed to higher levels than the quality standards.
- (b) Air pollutants of a country that are transported in the atmosphere.
- (c) Pollution that causes a negative impact on health and ecosystems.
- (d) Only (a) and (c)
- (e) Both (a) and (b)

Q2. What is/are the consequence(s) of a significant reduction in air pollutants over the last few decades?

- (a) The level of suffering caused by air pollution has decreased.
- (b) There has been a significant improvement in the quality of the air.
- (c) Pollution levels in the air are becoming unacceptably high.



(d) Several countries have exceeded their limits for emissions.

(e) All of these

Q3. Which of the following factors contribute to the deterioration of the respiratory system and early mortality?

(a) Transportation of air pollutants in the air.

(b) Maximum exposures to ground-level ozone.

(c) Long-term exposures to nitrogen dioxide.

(d) Only (a) and (b)

(e) Only (b) and (c)

Q4. Which of the following statements is/are correct based on the information provided regarding the European Environment Agency (EEA)?

(i) It is the air pollution data center of the European Union.

(ii) It helps in the review of the air pollution policies of the UN.

(iii) It contributes to European air quality improvement plans.

(a) Only (iii)

(b) Only (ii) and (iii)

(c) Only (ii)

(d) Only (i) and (iii)

(e) All of these

Q5. Why is it necessary to make targeted efforts to minimize emissions?

(a) to better safeguard human health in the interest of a sustainable society.

(b) to strengthen environmental and natural vegetation preservation.

(c) to cut down on the number of pollutants accumulated in the acid.

(d) Both (a) and (b)

(e) None of these

Q6. Which of the following statements most accurately describes the phrase "anthropogenic emissions" as used in the passage?

(a) a type of emission that ensures the long-term viability of nature.

(b) an emission that brings humans and the environment closer together.

(c) human-caused emissions that are less detrimental to the environment.

(d) human-caused emissions of greenhouse gases and pollutants.

(e) Emissions that have a serious impact on species and wildlife.

Q7. Choose the most appropriate synonym of the word 'PERSIST', as highlighted in the given passage.

(a) forswear

(b) renounce

(c) persevere

(d) abandon

(e) evacuate

Directions (8-14): Read the following passage and answer the questions given below. Some words are highlighted to help you answer some of the questions.

Whether you're the reader who rips through a new book each week or the one still **slogging through** that bestseller your friend recommended months ago, psychologists say your time is being well spent. And if it's been a while since your last date with a good book, the experts have a few reasons that might convince you to give it another go. One of the benefits of reading is simply that it provides enjoyment and pleasure. It can provide an escape from boredom or stress. Plus, reading has been shown to help us better understand and interact with other people, keep our brains sharp, expand our world views and grow as individuals. Stories allow us to feel connected with others and part of something bigger than ourselves. Reading can give us a sense of belongingness that we all instinctively want as human beings.

It's more likely to get lost in a book if you're reading a high-quality text, but "quality" in this case is subjective and something that gets determined by you. For some, it's a quick-moving plot that's **critical**, while for others engaging characters or a poetic writing style is most important if you want to get lost in the storyline. And some people are just more interested in one type of story versus another. Stories about other people teach us to be the types of people we want to be. Reading makes us think and feel in new and different ways. You give up some of your own habits and thoughts, and you take on your own



idea of being a different person in circumstances that you might otherwise never had been in. Researchers at a University showed in an experiment that reading actually satisfies that need for human connection because it can mimic what we feel during real social interactions.

Back in 2009, Oatley and his colleagues found that after reading one of two different versions of the same story - one an original piece of fiction and the other a retelling of the same story written in a non-fiction style - participants who read fiction changed in their personality traits more than those who read the non-fiction version of the story and reported feeling higher levels of emotions. Throughout life, reading activities aid to **rejuvenate** navigational learning skills and contextual memory. Objectively, Oatley and his colleagues haven't measured whether these changes might be labeled as "good" or "positive," but he says to think about it in terms of personal growth akin to how we want kids to grow and develop in their own ways. It is very important in the social world to understand others, to understand ourselves, and not just get stuck.

Q8. What is/are the advantage(s) of reading that the author describes in the passage?

- (a) It can be a fun way to pass the time when you're bored.
- (b) It brings pleasure and enjoyment.
- (c) It maintains our minds sharp and broadens our horizons.
- (d) Only (a) and (c)
- (e) All of these

Q9. What did university researchers demonstrate in an experiment?

- (a) Reading satisfies our want for interaction with people.
- (b) Reading helps us feel the same way we do in real-life social situations.
- (c) After reading fiction, the majority of people's personality features alter.
- (d) Only (a) and (b)
- (e) Only (b) and (c)

Q10. What, in the opinion of the author, is subjective and determined by the reader?

- (a) Presence of mind while reading
- (b) Quality while reading a book
- (c) Engaging characters in a book
- (d) A poetic writing style in a book
- (e) All of these

Q11. Which of the following statements is/are correct based on the information provided in the given passage?

- (i) Other people's stories teach us how to be the people we aspire to be.
 - (ii) Reading encourages us to think and behave in new and different ways.
 - (iii) If you wish to get immersed in the story, you'll need a poetic writing style.
- (a) Only (iii)
 - (b) Only (ii) and (iii)
 - (c) Only (ii)
 - (d) Only (i) and (iii)
 - (e) All of these

Q12. Choose the most appropriate antonym of the word "CRITICAL", as highlighted in the given passage?

- (a) Crucial
- (b) decisive
- (c) exigent
- (d) Pivotal
- (e) trivial

Q13. Which of the following idioms best illustrates the phrase "slogging through" as used in the passage?

- (a) let it all hang out
- (b) hammer away at
- (c) Be of the opinion that
- (d) push the boat out
- (e) Let one's hair down

Q14. Choose the most appropriate synonym of the word 'REJUVENATE', as highlighted in the given passage.

- (a) Impair
- (b) impede
- (c) uplift
- (d) Shrink
- (e) blunt

Directions (15-21): In the following paragraph, a few words have been omitted, each of which has been numbered. Select the most appropriate word from the given options to fill in the given blanks correctly in terms of contextual meaning and grammatical accuracy.

To ensure that visually impaired litigants are able to effectively pursue and _____(15)_____ their legal rights, the Delhi High Court has asked

the government to provide them with the court documents in Braille script. Moreover, the right to justice includes the right to receive documents, which legally _____(16)_____ the parties to a communication mode and language that they can easily _____(17)_____. The court's direction came while hearing an anticipatory bail plea filed by a visually impaired man. It is mandated to make available all necessary facilities _____(18)_____ and _____(19)_____ the recording of testimonies, arguments or opinions given by persons with disabilities in their preferred language and means of communication," the court said while _____(19)_____ the government to make arrangements to provide the documents in Braille. Taking note of the submission, the Judge said, "The parties are entitled to be well versed with the proceedings of the litigation they _____(20)_____ and the documents which materially affect their legal rights. Section 12 of the Rights of Persons with Disabilities Act, 2016 creates a _____(21)_____ on the state for providing access to justice to differently-abled persons".

Q15.

- (a) Cushion (b) Protect (c) Insulate
(d) Fortify (e) All of these

Q16.

- (a) averts (b) prevents (c) entitles
(d) obviates (e) hampers

Q17.

- (a) preclude (b) restrain (c) obturate
(d) decipher (e) All of these

Q18.

- (a) expedite (b) trammel (c) encumber
(d) constrain (e) forestall

Q19.

- (a) promising (b) occupying (c) engaging
(d) dictating (e) All of these

Q20.

- (a) tenant (b) sheath (c) pursue

- (d) desert (e) strand

Q21.

- (a) directive (b) injunction (c) mandate
(d) ordinance (e) All of these

Directions (22-23): Rearrange the following statements in the proper sequence to form a meaningful paragraph and then answer the questions given below.

(A) This is due to Russia's war on Ukraine, which have impacted the region when it was already experiencing fragile growth and rising commodity prices.

(B) However, the impact was indirect, rather than direct, given the relatively low proportion of exports and imports that go to and come from Russia and Ukraine.

(C) India is projected to grow at a slower rate over the current fiscal year, the World Bank said in its biannual South Asia Economic Focus.

(D) Given these challenges, governments need to carefully plan monetary and fiscal policies to counter external shocks and protect the vulnerable.

(E) The impact of the war has seen faster inflation, deteriorating current account balances and growing fiscal deficits.

Q22. Which of the following will be the correct sequence of the given statements to form a coherent paragraph?

- (a) ACEDB (b) CDBEA (c) EABCD
(d) CAEBD (e) DBEAC

Q23. Which one of the following statements contains an error?

- (a) C (b) E (c) A
(d) D (e) B

Direction (24-28): In each of the questions given below, a statement with a highlighted phrase is given.

The highlighted phrase may or may not have been used correctly in the given statements. Choose the appropriate phrase/phrases from the given options which could replace the highlighted one to make the statements

grammatically and contextually correct. If the highlighted phrase is correct and needs no replacement then choose option “e” as your response.

Q24. The Constitution states that the official language used for communication shall be the language **that have been in use since** the adoption of the Constitution.

(i) that has been in using since

(ii) that had been in use since

(iii) that has been in use since

(a) Only (iii) (b) Only (i) and (iii)

(c) Only (ii) (d) Only (i) and (ii)

(e) No correction required

Q25. Official figures show **retail inflation has increased significant** just four days after the RBI stated it would emphasize inflation over growth.

(i) Retail inflation has increased significantly

(ii) Retail inflation have been increasing rapidly

(iii) Inflation in the retail sector has risen sharply

(a) Only (i) and (iii) (b) Only (iii)

(c) Only (i) and (ii) (d) Only (ii)

(e) No correction required

Q26. The recent coronavirus pandemic **has taught us all a lot about what** a large-scale, global public health problem looks like.

(i) has thought us a lot about all what

(ii) has taught a lot us all about which

(iii) have taught all us a lot about what

(a) Only (iii) (b) Only (i) and (iii)

(c) Only (ii) (d) Only (i) and (ii)

(e) No correction required

Q27. Given the long list of diplomats from across the world, one may presume that India **was actively involved in resolving** the European crisis.

(i) was actively involving in resolving

(ii) was active involved into resolving

(iii) was actively involve for resolving

(a) Only (i) and (iii) (b) Only (iii)

(c) Only (i) and (ii) (d) Only (ii)

(e) No correction required

Q28. Despite the border crisis, India's commerce with China has achieved new highs, and **it**

continues to be a largest beneficiary of Asian Infrastructure and Investment Bank financing.

(i) it continue to be the largest beneficiary

(ii) it continues to be the largest beneficiary

(iii) it continue to be the largest beneficial

(a) Only (iii) (b) Only (i) and (iii)

(c) Only (ii) (d) Only (i) and (ii)

(e) No correction required

Directions (29-31): In the following questions, two columns are given containing three sentences/phrases each. In the first column, sentences/phrases are A, B and C and in the second column, the sentences/phrases are D, E and F. A sentence/phrase from the first column may or may not connect with another sentence/phrase from the second column. Each question has five options, four of which display the sequence(s) in which the sentences/phrases can be joined to form a grammatically and contextually correct sentence. Choose the appropriate option. If none of the given options forms a correct sentence after combination, mark (e), i.e. “None of these” as your answer.

Q29. COLUMN I

(A) It shall not apply to the transport of any live elephant through.

(B) The Delhi government will issue new COVID-19 guidelines.

(C) Such person has obtained prior permission from the government.

COLUMN II

(D) not to encourage the sale and purchase of captive elephants.

(E) hold a final round of meeting on its report on the legislation.

(F) for schools in view of the slight rise in viral cases in the city.

(a) Only A-E and B-D

(b) Only B-F

(c) Only A-F and B-E

(d) Only C-E

(e) None of these

Q30. COLUMN I

(A) Chief Minister warned that the government will not spare anyone found indulging in riots

(B) It reminded the Governor of the need to discharge constitutional duties constructively

(C) It was done while pointing to the cordiality and productive relationship enjoyed by them

COLUMN II

(D) and the official protocols and courtesies extended to the constitutional head of the State.

(E) a phenomenon associated with a warming of the Central Pacific and drying up of the rains.

(F) current indication has suggested normal rainfall in the northern parts of peninsular India.

(a) Only A-E and B-D (b) Only C-E

(c) Only A-F and B-E (d) Only B-F

(e) None of these

Q31. COLUMN I

(A) Nefarious attempts were being constantly made to undermine

(B) The authority has decided to launch an investigation and audit

(C) The Prime Minister made the announcement while paying homage

COLUMN II

(D) Provide students foundational education in language and specialized education.

(E) on getting complaints about a school increasing fees according to its wishes.

(F) they have been established by the city government in partnership with them.

(a) Only A-D and B-F (b) Only C-F

(c) Only A-E and B-D (d) Only B-E

(e) None of these

Direction (32-36): In each of the questions given below, two sentences with a blank in each are given. The given blanks must be filled with the same word. Select a word or words from the choices below that can be used to fill in both of the given blanks.

Q32.

(A) There needs to be a basic rethink on the _____ of the inflation-targeting framework itself.

(B) Fortunately, the medicine had the _____ to reduce the amount of pain John was feeling.

(i) Neglect (ii) efficacy (iii) sinking

(a) Only (ii)

(b) Only (i) and (iii)

(c) All of these

(d) Only (i) and (ii)

(e) Only (iii)

Q33.

(A) The _____ way to control inflation for India is for us to create jobs and output.

(B) The scholar's _____ goal was to get his research published in a medical journal.

(i) reckless (ii) ultimate (iii) eventual

(a) Only (iii) (b) Only (i) and (ii)

(c) All of these (d) Only (ii) and (iii)

(e) Only (ii)

Q34.

(A) Nowadays, people's _____ of inflation is far higher than what the CPI number indicates.

(B) Your _____ of the world around you is dictated primarily by your five senses.

(i) pomposity

(ii) Affectation

(iii) Perception

(a) Only (ii)

(b) All of these

(c) Only (i) and (iii) (d) Only (i) and (ii)

(e) Only (iii)

Q35.

(A) Our country is being _____ by religious divisions that have reached a new and dangerous level.

(B) Bullies have _____ the victims by making fun of them and encouraging others to do so as well.

(i) Mortified

(ii) Humiliated

(iii) Appeased

(a) Only (ii)

(b) Only (i) and (iii)

(c) All of these

(d) Only (i) and (ii)

(e) Only (iii)

Q36.

(A) A fundamental freedom is _____ when the freedom of conscience is harmed.

(B) Our ability to make rational decisions is sometimes _____ by our emotions.

(i) impaired

(ii) blunted

(iii) vitiated

(a) Only (ii)

(b) All of these



- (c) Only (i) and (iii) (d) Only (i) and (ii)
(e) Only (iii)

Q37. Five grammatically correct and contextually meaningful sentences are given in this question.

A paragraph can be formed by rearranging four of these sentences. You must select the sentence that is incoherent and does not fit in with the rest of the sentences.

- (a) The second system permits the social insurance fund to cover private healthcare spending.
(b) Universal health care has become a well-accepted objective of public policy around the world.
(c) In the first approach, health care is provided as a free public service, just like a public library.
(d) This rapid expansion in transportation is one of India's most massive changes since liberation.
(e) The basic idea of universal health care is that no one should be deprived of quality health care.

Direction (38-40): In each of the following questions, three statements are given. For each question, three starters are also given which can be used to integrate all three statements into a meaningful and coherent composition. Select a starter or starters from the following options that can be used to combine the given statements in a grammatically accurate and contextually meaningful manner.

Q38.

- (A) training future leaders of India's public transportation system,
(B) Indian Railways officers will need to work together
(C) because they will be serving in the organization for decades
(i) however (ii) apart from (iii) anyhow
(a) Only (ii) (b) Only (i) and (iii)
(c) All of these (d) Only (i) and (ii)
(e) Only (iii)

Q39.

- (A) merging services to adapt training for newly hired officers,
(B) early and mid-career training programs are also required
(C) since the focus should be on increasing the ability to manage
(i) in addition to
(ii) nevertheless
(iii) besides
(a) Only (ii) (b) Only (i) and (iii)
(c) Only (iii) (d) Only (i) and (ii)
(e) All of these

Q40.

- (A) in a system based on social insurance, public service is crucial because,
(B) in the absence of public health institutions, patients are at risk of racing to
(C) Expensive hospitals every other day, wasting resources and increasing costs
(i) Due to (ii) even (iii) instead
(a) Only (iii) (b) Only (i) and (iii)
(c) All of these (d) Only (i) and (ii)
(e) Only (ii)

Directions (41-45): Study the following information carefully and answer the given questions.

There are three rows i.e., row1, row2 and row3 such that row2 is in the north of row 3 and row 1 is in the north of row 2. Six persons sit in each row. All of them face the north direction. The persons sit in row 1 are exactly opposite to persons sit in row 2 and vice versa and the persons sit in row 2 are exactly opposite to persons sit in row 3 and vice versa. The persons are from A to R as per the English alphabetical series. All the information is not necessarily in the same order.

Q sits third to the left of G. Q sits at the extreme end. A sits to the north of Q. Two persons sit between A and the one who sits immediate left of H. The one who sits to the north of H is the only neighbor of B. N sits second to the left of E. E sits neither adjacent to G nor at the extreme end. One person sits between B and C. C doesn't sit adjacent to N. The number of persons sits between A and H is same as between L and D who sits south of R.



R sits at the extreme end. P sits second to the left of J in the same row as C. F sits just next to J. O sits to the south east of K. G and I are not immediate neighbours.

Q41. How many persons sit between Q and the one who sits immediate right of O?

- (a) One (b) Two (c) Three
(d) None (e) More than three

Q42. Which among the following statement(s) is/are true?

- I. A and H sit in the same row
II. H sits to the north west of G
III. K sits at the extreme end

- (a) Both I and II (b) Both II and III
(c) Only I (d) Both I and III
(e) Only III

Q43. Four of the following five are alike in a certain way and thus form a group. Which of the following one does not belong to the group?

- (a) N-Q (b) I-L (c) C-N
(d) E-D (e) H-M

Q44. Who among the following sits third to the left of the person who sits at extreme end in row 1?

- (a) J (b) C (c) K
(d) E (e) M

Q45. If all the persons sit in row 3 are arranged in the alphabetical order from left to right, then the position of how many persons remains unchanged?

- (a) One (b) Two (c) Three
(d) None (e) More than three

Directions (46-49): Study the following information carefully to answer the given questions.

In a certain code language: -

“More migrated towards pound” is written as ‘6EN 7DQ 9SU 10DN’

“Hold the laugh store” is written as ‘6DI 5EU 7ET 7HM’

“Wait recorded from changes” is written as ‘10DS 6MG 6TX 9SD’

Q46. In the given coding language, which of the following will be the code for “Puzzled”?

- (a) 6EN (b) 4UY (c) 8RD
(d) 9DQ (e) None of these

Q47. In the given coding language, which of the following will be the code for “Stronger”?

- (a) 10DR (b) 6DN (c) 7RK
(d) 10RU (e) None of these

Q48. Which of the following words could be coded as “7KC 8TN”?

- (a) Death Magnet (b) Black Magic
(c) Black Magnet (d) Track Progress
(e) Blue Moon

Q49. Which of the following will be the code for ‘Mental’?

- (a) 50N (b) 7LM (c) 8LN
(d) 5QL (e) None of these

Q50. With restaurants affected due to the COVID-19 crisis, a restaurant in Pune has come up with a unique scheme to attract customers with 'Win a Bullet bike' contest for those who finish a massive Bullet Thali within an hour.

Bullet Thali is a massive non-veg thali which consists of around 12 types of dishes made with 4 kgs of mutton and fried fish. The owner is happy that the response has been great and **people are visiting** to try the thali and participating in this unique contest. As per owner, the hotel sells around 65 Thali daily.

Which of the following can be inferred from the above statement?

(I) Bullet bike has a huge craze and demand among people in Pune.

(II) Promotion is only source to make restaurant popular and gain income.

(III) Non-vegetarians are more in count as compared to Vegetarians in Pune.

- (a) Only II (b) Only I and III
(c) Only I (d) Only III (e) Only II and III



Direction (51-55): Study the given information and answer the related questions:

Nine persons K, L, M, N, O, P, Q, R and T visit Balaji temple in three months i.e., May, August and November on 5th, 7th and 20th of the same year. They go by different vehicles. All the information is not necessarily in the same order as given.

R goes by airplane on even date. Four persons visit between R and the one goes by bus. P visits two person before the one who goes by bus. The number of persons visit after P is two more than the number of persons visit before L. T goes by train just after the one goes by car and both of them visits in different months. Three persons visit between T and M. M and the one who goes by chopper do not visit in the same month. The person who goes by taxi visits before K who visits before the one who goes by Chopper and they all three visits on the same date. N goes by Bike. O does not go by chopper and bike but visits after the one who goes by boat. One of them goes by Jeep.

Q51. Which among the following combination is correct?

- (a) Q- chopper (b) O-bus (c) K-Jeep
(d) M-boat (e) All are correct

Q52. How many persons visits between Q and the one who goes by bike?

- (a) None (b) One (c) Two
(d) Three (e) More than three

Q53. Who among the following visits on 20th August?

- (a) T (b) L (c) P
(d) R (e) None of these

Q54. ___ goes by bus on ___?

- (a) O, 5th August (b) K, 5th August
(c) O, 5th May (d) Q, 20th May
(e) P, 20th November

Q55. If N is related to airplane, P is related to chopper, in the same way, ___ is related to car?

- (a) K (b) O (c) T

- (d) M (e) None of these

Directions (56-60): A number arrangement machine when given an input line of numbers rearranges them following a particular rule in each step. The following is an illustration of input and rearrangement.

Input: 2375 9824 1673 8253 4213 5184

Step I: 2357 2489 1367 2358 1234 1458

Step II: 7532 9842 7631 8532 4321 8541

Step III: 4321 7532 7631 8532 8541 9842

Step IV: 32 53 63 53 54 84

Step V: 1 2 3 2 1 4

Step V is the last step of the input. As per the rules followed in the above step, find out the appropriate step for the given output.

Input: 3472 6721 9733 7123 5361 8417

Q56. In which of the following step the elements "9733 7321 6531" found in the same order?

- (a) Step I (b) Step IV (c) Step III
(d) Step II (e) no such step

Q57. What is difference between the fourth element from the left in step IV and fourth element from the right in step V?

- (a) 31 (b) 63 (c) 42
(d) 61 (e) None of these

Q58. How many steps will be required to complete the rearrangement?

- (a) V (b) IV (c) II
(d) More than VI (e) VI

Q59. Which of the following element would be at the third from the right of the element which is sixth from the right end in step II?

- (a) 9733 (b) 6531 (c) 7123
(d) 8417 (e) None of these

Q60. Which element is exactly between the third element from left end and second element from right end in step III?

- (a) 7321 (b) 7621 (c) 8741
(d) 6531 (e) Can't be determined



Direction (61-62): Dismissing four petitions challenging the collection of fine in cars when the drivers were found without a mask, the Delhi high court said it is mandatory to wear a mask in a private car even when the driver is alone in the car, as a vehicle is considered a public place. The high court said a mask acts as Suraksha Kavach, which would prevent the spread of the deadly virus.

Q61. Which of the following diminish the verdict issued by Delhi High Court?

- (a) There will be penalty if anyone will break the rules to wear mask.
- (b) Delhi government has decided to distribute masks at public places.
- (c) Mask is not compulsory for police personnel if they are driving alone.
- (d) Delhi Transport department has also made compulsory to wear masks in DTC buses and DMRC.
- (e) Both (b) and (d)

Q62. Which of the following can be hypothesized from the above statement?

- (I) People will follow the rules to wear mask even they are alone in car.
 - (II) Awareness among people will be spread as court has termed "Suraksha Kavach" to mask.
 - (III) Less car will be seen on the roads of Delhi after verdict of High Court.
- (a) Only III
 - (b) Only I and II
 - (c) Only II and III
 - (d) Only II
 - (e) All I, II & III

Direction (63-65): Study the given information and answer the following questions:

Four persons Rohan, Vikas, Deepak and Yash are married to four girls named Pragya, Surbhi, Poonam, Anjana. They all have four kids (one each) named Tina, Anu, Monty, Puja. All the information is not necessarily in the same order as given.

Puja is not the child of Rohan and Vikas. Surbhi is not married to Vikas and Deepak. Yash is not the father of Puja nor married to Surbhi and Poonam. Anjana is not the mother of Puja and Tina. The

mother of Anu is not married to Vikas. Poonam is neither the mother of Monty nor the wife of Deepak. Monty is not the child of Yash.

Q63. Who among the following is the child of Pragya?

- (a) Tina
- (b) Monty
- (c) Puja
- (d) Anu
- (e) Can't be determined

Q64. Which among the following combination is correct?

- (a) Poonam- Rohan
- (b) Anjana- Deepak
- (c) Surbhi- Vikas
- (d) Pragya- Puja
- (e) Poonam- Anu

Q65. Which among the following statement is/are true?

- (a) Surbhi is the mother of Anu
- (b) Rohan is the husband of Surbhi
- (c) Poonam is the wife of Rohan
- (d) Puja is not the child of Pragya
- (e) Vikas is the husband of Anjana

Directions (66-69): Each of the questions below consists of a question and two statements numbered I, and II given below it. You have to decide whether the data provided in the statements are sufficient to answer the question. Read all the statements and answer the following questions.

- (a) If the data in statement I alone is sufficient to answer
- (b) If the data in statement II alone is sufficient to answer
- (c) If the data either in statement I alone or instatement II alone is sufficient to answer
- (d) If the data given in both statements, I and II together are not sufficient to answer
- (e) If the data in both the statements I and II together are necessary to answer

Q66. Seven persons are attending the seminar on seven consecutive days starting from Monday. Who among the following attends the class on Saturday?

Statement I: Three persons attend class between A and E. G attends class just before the one who



attends class two persons after C. F attends class before D.

Statement II: More than one person attend class before A. G attends class two persons after F. F attends class after Wednesday. The number of persons attends class before A is one more than after G.

Q67. Eight persons-A, B, C, D, E, F, G and H go to market one after the other but not necessarily in the same order. Who among the following goes first to the market?

Statement I: Two persons go between G and C. A goes just after C who goes three persons before F. The number of persons goes after H is same as before G. H does not go before F.

Statement II: More than two persons go between C and H. G goes before E who doesn't go last to the market. Neither A nor D goes to the market last.

Q68. Eight persons sit around a circular table and face outwards. Who among the following sits second to the left of W?

Statement I: R sits opposite to the one who sits immediate right of S. Two persons sit between W and the one who sits immediate left of P.

Statement II: V sits adjacent to S. T sits second to the left of S. R is an immediate neighbor of T but not S. P is an immediate neighbor of both W and S.

Q69. A family of three generation have six members. How many male members are there in the family?

Statement I: S is nephew of T. Q is sister-in-law of T and vice versa. N is grandparent of only child of O. S is not married.

Statement II: T is unmarried. O is the only son of N and is married. M is parent of T.

Directions (70-74): Study the following information carefully to answer the given questions.

Seven friends Hema, Vikas, Piya, Neema, Kiran, Shiv and Arya are going to visit famous places of India named as Hawa mehal, Golden temple, Taj mahal, Red fort, Robbers cave, Qutub minar and Lotus temple. Each of them goes on different days

of the same week starting from Sunday. All the information is not necessarily in the same order. Vikas goes to either Taj mahal or Golden temple but not on Monday. The number of persons who goes between Arya and Vikas is same as the number of persons who goes between Arya and kiran. Only one person goes between Hema and Neema. Arya doesn't go to Hawa mahal and Qutub minar. Shiv goes to Golden temple. Piya goes just after Arya but not on the last day of the week. The one who goes on Wednesday goes to Red fort. More than three persons goes before Piya. Vikas goes before Piya who doesn't goes to Robbers cave and Hawa mehal. Neema goes after Vikas. Kiran goes to Lotus temple.

Q70. Who among the following goes on Thursday?

- (a) The one who goes to Lotus temple
- (b) Arya
- (c) Neema
- (d) Shiv
- (e) The one who goes just after Hema

Q71. How many persons go between Shiv and Piya?

- (a) One
- (b) Two
- (c) Three
- (d) Four
- (e) Five

Q72. Who among the following goes to robbers cave?

- (a) Neema
- (b) Shiv
- (c) None of these
- (d) Arya
- (e) Hema

Q73. Four of the following five are alike in a certain way and hence form a group. Which is the one that does not belong to the group?

- (a) Shiv- Hawa mahal
- (b) Hema- Taj mahal
- (c) Neema- Red fort
- (d) Piya- Lotus temple
- (e) Arya - Qutub minar

Q74. Which of the following statement is not true?

- (a) Shiv goes on sunday
- (b) Neema goes to Red fort
- (c) Only two persons goes between Vikas and Piya
- (d) Piya goes on Friday
- (e) Kiran goes On Monday



Direction (75-78): Study the following information and answer the related questions:

A#B means A is the father of B

A%B means A is the child of B

A&B means A is the brother of B

A@B means A is the sister of B

A*B means A is the wife of B

Q75. If the expression 'R#B%H%C&L' is true, then what is the relation of C with respect R?

- (a) Sister (b) Father-in-law (c) Uncle
(d) Mother (e) None of these

Q76. Who among the following is the father of S according to the expression 'S@K&T%V*N&G'?

- (a) N (b) G (c) S
(d) T (e) Can't be determined

Q77. According to the expression 'U*K, E%K, E&J, J*F#H', find, how many children K has?

- (a) Three (b) One (c) CND
(d) Two (e) None of these

Q78. In the expression, 'A#W@Z&K*C, K%D', find the number of females in the family?

- (a) Five (b) Four (c) Three
(d) Two (e) None of these

Direction (79-80): With an increased variability of monsoons and rapidly depleting groundwater tables, large parts of India are reeling under water stress and drought like situation. Here, one intervention that has been tried out in various States, and perhaps needs to be taken up on a bigger scale, is the construction of farm ponds, it can be cost-effective structures that transform rural livelihoods. They can help enhance water control, contribute to agriculture intensification and boost farm incomes.

Q79. Which of the following can diminish the importance farm ponds?

- (a) Farm Ponds is cost effective and it transform rural livelihoods.
(b) It will help to enhance water control, agricultural reforms and can boost farmers' incomes.

(c) It can used as intermediate storage which may leads to evaporation loss.

(d) Both (a) & (b)

(e) Both (b) & (c)

Q80. Which of the following statement(s) is/are false in context of the given statement?

(a) The problem of lower water table has captivated the entire country.

(b) Farm ponds can help in the process of water control.

(c) Construction of farm ponds hamper the agricultural modification & rural subsistence.

(d) Farm ponds can be a viable investment option

(e) None of these.

Directions (81-84): Study the following alphanumeric series carefully and answer the questions given below:

U 3 7 @ # 4 5 T & ! F U 9 M 6 3 © G 5 Ω 3 A Z 5 2
€ 8 β L P 3

STEP I- The numbers which are immediately preceded by a letter are arranged to the immediate right of the element which is third from the right end (in the series) in ascending order.

STEP II- - The symbol which is immediately followed by a letter is interchanged its position with respect to the element just before it.

STEP III- The letters which are immediately preceded by a symbol are dropped from the series.

(STEP II is applied after STEP I and STEP III is applied after STEP II)

Q81. How many numbers are arranged at the end of the series in the step-I?

- (a) One (b) Three (c) Four
(d) Five (e) More than five

Q82. How many numbers are immediately followed by symbols in step-II?

- (a) One (b) Two (c) Four
(d) Five (e) None of these



Q83. Which of the following letter is 6th to the right of 3rd symbol from the left end in step III?

- (a) L (b) U (c) T
(d) M (e) None of these

Q84. What is sum of numbers which are 6th from the right end in step I and 5th from the left end in step III?

$$3+3=6$$

- (a) 11 (b) 12 (c) 6
(d) 13 (e) None of these

Q85. Owner of Restaurant A has decided to decrease the price of Full Thali to attract the customers while the Owner of Restaurant B will keep the price unchanged. Both the owner has same motive to increase the customer base and increase their income.

Which of the following can be hypothesized from the above statement?

(I) All the Customer of Restaurant B will move to Restaurant A to avail the benefit of price slashed.

(II) Some of the customer will think quality of Restaurant A is not as good as Restaurant B.

(III) Infrastructure and kitchen of Restaurant B is more modern and spacious.

- (a) Only I and II (b) Only III
(c) Only II and III (d) Only I and III
(e) None of them

Directions (86-90): Study the following information carefully and answer the given questions.

Eight Cricketers- A, B, C, D, E, F, G and H sit around a circular table facing the center in a dinner party but not necessarily in the same order. Each one of them is from a different country.

F sits second to right of the cricketer who is from South Africa. B is not from West Indies. Only one person sits between C and the cricketer who is from Sri Lanka. H sits third to left of the cricketer who is from New Zealand. The cricketer who is from Australia sits second to left of the cricketer who is from Zimbabwe. The cricketer who is from India is an immediate neighbor of the cricketer who is from South Africa. Two cricketers sit between the cricketer who is from India and B. C and E are immediate neighbors of each other.

Neither C nor E is an immediate neighbor of B and the cricketer who is from South Africa. The cricketer who is from England sits second to right of D. D is neither the cricketer of South Africa nor India. G and the cricketer who is from West Indies are immediate neighbors of each other.

Q86. Who among the following sits second to the right of the cricketer who is from West Indies?

- (a) B (b) H
(c) The cricketer who is from India
(d) E (e) None of these

Q87. Who among the following cricketer is from Zimbabwe?

- (a) C (b) F (c) B
(d) G (e) None of these

Q88. Who among the following sits opposite to E?

- (a) A (b) H (c) G
(d) B (e) None of these

Q89. Which of the following statement is true about A?

- (a) A is from Australia
(b) G is an immediate neighbor of A
(c) A sits opposite to the one who sits second to the left of D
(d) H does not sit immediate right of A
(e) None is true

Q90. F is from which country?

- (a) India (b) England
(c) South Africa (d) West Indies
(e) None of these

Direction (91-93): A set of 2 equations is given below. Read the information carefully and answer the question based on it.

1. $x^2 - px + q = 0$... Equation (I)

2. $x^2 - (p - 2)x + (q - 4) = 0$ Equation (II)

Equation (I) has 'm' and 3 as its roots while equation (II) has 'm' and 1 as its roots.



Q91. Find the value of 'm'.

- (a) 3 (b) 2 (c) 4
(d) 6 (e) 5

Q92. Find the value of '2p + q'.

- (a) 12 (b) 8 (c) 17
(d) 16 (e) 10

Q93. Another equation (III) $a^2 - 7a + 10 = 0$ is given. Which of the following is/are correct about it?

1. Roots of equation (III) are less than that of equation (II).
2. Equation (III) has one root equal to value of 'm'.
3. Equation (III) has roots greater than $(\sqrt{2} - \sqrt{2})$.
(a) Only 1 and 3 (b) Only 1 and 2
(c) Only 2 and 3 (d) None of the above
(e) All of the above

Q94. There are two trains A and B. Train A starts from point X at 8 AM towards point Y. Another train B starts at 9 AM from point Y towards point X. If they meet at 11 AM and speed of A is 24 kmph, while that of B is 36 kmph. Find distance between X and Y?

- (a) 144 km (b) 156 km
(c) 160 km (d) 136 km (e) None of these

Q95. Average age of A, B and C is 20 years and average age of B and C was 12 years when A was born. If B is 21 years old, then find the age of C 6 years hence?

- (a) 27 years (b) 21 years (c) 33 years
(d) 39 years (e) 18 years

Q96. A boat covers a certain distance in upstream in 6 hours 2 minutes and comes back to starting point with current in 2 hours 56 minutes. If boat's upstream speed is 15.05 kmph, then find the distance (approximately) travelled by boat in downstream in 7 hours?

- (a) 240 km (b) 180 km (c) 210 km
(d) 150 km (e) 105 km

Q97. An article is marked up by P% above the cost price. If shopkeeper offers discount of 25% and still earns a profit of 35%. For

earning a profit of 71%, how much discount should be offered by shopkeeper?

- (a) 12.5% (b) 10% (c) 7.5%
(d) 5% (e) None of these

Q98. A two-digit number decreases by 18 when it's both digits are written in reverse order. If unit digit of original number is equal to the unit digit of 22^6 . Find the product of both digits of the number?

- (a) 24 (b) 35 (c) 15
(d) 30 (e) 48

Direction (99-103): In a class, there are total 50 students in class and each student study at least one of three subjects – Mathematics, Science and Hindi. No student studies both Science and Mathematics but not Hindi. Four students study all of these subjects. Sum of number of students who study only Hindi and only Mathematics is 11. 40% of number of students who study only Science is equal to the number of students who study only Hindi. Number of students who study both Hindi and Science but not Mathematics is equal to thrice the number of students who study all these subjects. Number of students who study both Hindi and Mathematics but not Science is $33\frac{1}{3}\%$ less than number of students who study both Hindi and Science but not Mathematics.

Q99. What is the number of students who study both Hindi and Science?

- (a) 16 (b) 18 (c) 12
(d) 15 (e) 14

Q100. What is the number of students who study exactly two subjects?

- (a) 24 (b) 26 (c) 20
(d) 28 (e) 22

Q101. Find the number of students who study only Science is what percentage more or less than that who study both Hindi and Science but not Mathematics?

- (a) 20% (b) $33\frac{1}{3}\%$ (c) $16\frac{2}{3}\%$
(d) 25% (e) 40%



Q102. Number of students who do not study Mathematics is how much more or less than that who do not study Hindi?

- (a) 3 (b) 10 (c) 11
(d) 17 (e) 13

Q103. What is the ratio of number of students who study Hindi to the number of students who do not study Hindi and Mathematics?

- (a) 1: 2 (b) 3: 2 (c) 4: 3
(d) 2: 1 (e) 3: 1

Direction (104-107): There are two villages A and B. Ratio of population of village A and that of village B is 3: 2. Ratio of male population to female population in village A is X: Y and that in village B is Y: X.

Difference between the number of males in village A and that of female in village B is 880.

Q104. Find the number of females in village B?

- (a) 2640 (b) 880 (c) 1320
(d) 1760 (e) Can't be determined

Q105. Find the number of males in village A?

- (a) 880 (b) 1760 (c) 2640
(d) 2520 (e) Can't be determined

Q106. Number of females in village B is how much percent more/less than that of village A?

- (a) $33\frac{1}{3}\%$ (b) $66\frac{2}{3}\%$ (c) 40%
(d) None of these (e) CND

Q107. If female population in village A is 120 more than male population in same village, then find the total population of village B?

- (a) 3600 (b) 5400 (c) 4500
(d) 2700 (e) Can't be determined

Direction (108-110): A set of 2 number series is given below. Both series follow a similar pattern. Answer the questions based on it using information given below:

I. 5, 6, 13, 40, 161, 806

II. 2, p, q, r, s

Q108. Find the value of s.

- (a) 22 (b) 82 (c) 89
(d) 84 (e) 77

Q109. If nth term of series II is 2677, then find the value of 'n'.

- (a) 11 (b) 13 (c) 9
(d) 7 (e) 8

Q110. Find the value of (r - pq).

- (a) -3 (b) 5 (c) 0
(d) -1 (e) 1

Directions (111-115): Read the given data carefully and answer the question based on it.

There are 3 vessels named – A, B and C. All contain mixture of milk, water and juice. Vessel B contains mixture of volume 150 liters. Ratio of quantity of juice and water in vessel B is 3: 2 while that of milk and water is 1: 2. Water in vessel B is 66.67% more than juice in vessel C. Juice in vessel A is 80% of total juice in vessel B and C taken together. Water in vessel C is 20% less than juice in vessel B. In vessel A, ratio of water and juice is 5: 6. Ratio between milk and water in vessel C is 5: 4. Milk in vessel A is 2% less than total milk in vessels B and C together.

Q111. Find the ratio between total milk in vessel A and B together and water in vessel B and C together.

- (a) 123: 110 (b) 87: 74 (c) 117: 101
(d) 134: 115 (e) None of these

Q112. If 36 liters' mixture from vessel A is taken out, then find the difference between quantity of juice in vessel A and that in vessel B.

- (a) 5 liter (b) 12 liter (c) 3 liter
(d) 1 liter (e) 7 liters

Q113. Find the sum of amount of quantity in vessel B and that in vessel A together.

- (a) 315 liters (b) 402 liters
(c) 417 liters (d) 354 liters
(e) 378 liters

Q114. From vessel B, 9 liters of mixture is taken out, in next step, 18 liters mixture is again taken out from same vessel. In final step, 27 liters mixtures is taken out from same vessel, then find the difference between amount of milk and juice remained finally in this vessel.

- (a) 16 liters (b) 32 liters (c) 24 liters
(d) 28 liters (e) 36 liters

Q115. If from vessel A, vessel B and vessel C 20%, 40% and 55% quantity taken out and put into another vessel X, then find the difference between quantity of water and juice in the mixture.

- (a) 4.2 liter (b) 5.4 liter (c) 3.7 liter
(d) 4.7 liter (e) 6.3 liter

Q116. Average weight of 5 students in a class increases by 4 kg when weight of teacher is also included. If sum of average weight of 5 students and weight of teacher is 104 kg. Find the weight of teacher?

- (a) 48 kg (b) 54 kg (c) 64 kg
(d) 72 kg (e) 42 kg

Q117. X men can finish a work in Y days. $0.9X$ women can finish $\frac{1}{3}$ rd of the same work in $(Y-8)$ days. If $0.8X$ women can complete $\frac{1}{3}$ rd of the work in 36 days. Find $0.5X$ men can finish $\frac{1}{4}$ th of the same work in how many days?

- (a) 10 days (b) 80 days (c) 40 days
(d) 20 days (e) 60 days

Q118. A man spends 25% of his monthly salary on Rent and 32% on Groceries. He invests remaining salary in the ratio of 11: 5 in Mutual Funds and Fixed Deposits. If difference between his yearly mutual funds and fixed deposit amount is Rs.77400, then find the amount he spends each month on Groceries.

- (a) Rs.12800 (b) Rs.9600 (c) Rs.6400
(d) Rs.7200 (e) Rs.11200

Q119. A bag has balls of three colors. It has 8 red balls, x green balls and y blue balls. If

probability of picking one green ball and that of picking one blue ball out of bag is equal, then find the number of blue balls. Probability of picking one red ball is 0.5.

- (a) 2 (b) 4 (c) 5
(d) 6 (e) 3

Q120. A man invests Rs. X in a scheme at 12% rate of interest for 8 years. After 8 years, he reinvests the amount received at same rate of interest for same time duration. If interest received from reinvestment is Rs.5730.4 more than Rs. X. Find the value of X.

- (a) 6500 (b) 5400 (c) 7800
(d) 5900 (e) None of these

Q121. A person took a loan of Rs.1500 from an investor at 20% per annum on compound interest for 2 years. But he paid only 80% of amount after 2 years. And investor put some penalty on remaining amount. He paid Rs.520 including penalty amount after some time. Find the value of penalty amount.

- (a) Rs.104 (b) Rs.76 (c) Rs.58
(d) Rs.92 (e) Rs.88

Q122. Pipe A can fill half of the tank in 6 hours 2 min. Pipe B can fill the same tank completely in 18 hours 5 min while pipe C can empty the fully filled tank in 9 hours. If all the pipes are opened simultaneously then in how much time (approx.) 80% of tank will be filled.

- (a) 29 hours (b) 24 hours (c) 35 hours
(d) 33 hours (e) 27 hours

Q123. A and B invest in a business in the ratio of 2: 3. After X months, B left the business while C joins the business with twice of investment as compared to that of B. C invests for 2 months more than B. After a year, C received $\frac{5}{9}$ th share of total profit. Find the time period for which B invested the amount?

- (a) 4 months (b) 6 months (c) 8 months
(d) 5 months (e) 7 months

Q124. A, B and C invest in a business. A invests twice as compared to B and C invests 90% more than A's investment. If all invest for



same duration and earned a total profit of Rs.2109, then find the approximate profit share of A?

- (a) Rs.300 (b) Rs.1140 (c) Rs.880
(d) Rs.620 (e) Rs.710

Q125. Cost price of an article is Rs. X and its marked price is 400% more than cost price. To gain a profit of 100%, what percent of discount should be offered on this particular article?

- (a) 60% (b) 40% (c) 50%
(d) 75% (e) 100%

Directions (126-130): In the given questions, two quantities are given, one as Quantity I and another as Quantity II. You have to determine relationship between two quantities and choose the appropriate option

- (a) Quantity I > Quantity II
(b) Quantity I < Quantity II
(c) Quantity I \geq Quantity II
(d) Quantity I \leq Quantity II
(e) Quantity I = Quantity II or No relation

Q126.

Quantity I: $\sqrt{2\sqrt{2} - 1} = 3$

Quantity II: $\sqrt[3]{-2} = \sqrt{625}$

Q127. A's age 'x' years ago is equal to B's age after 'x' years. Present age of C is twice of the present age of B and C's age 'x' years ago is equal to A's age after 2x years.

Quantity I: 6 years

Quantity II: Difference between present age of A and C.

Q128. A person offers same discount percent on two articles X and Y.

He marks up articles by 40% and 15% respectively above the cost price and selling price of article X and Y are Rs.280 and Rs.276 respectively.

Quantity I: Cost price of article Y.

Quantity II: marked price of article X.

Q129. Ratio of area of a circle and area of rectangle is 11: 15. Breadth of rectangle is twice

of the radius of circle. Sum of length and breadth of rectangle is 58 cm.

Quantity I: 600 cm²

Quantity II: Area of rectangle (in cm²)

Q130.

1: $2^{3x+y} = \sqrt{32}$

2: $2^{2x+\frac{3y}{2}} = \sqrt{32}$

Quantity I: ($\sqrt{2} + \sqrt{2}$)

Quantity II: 2

Direction (131-136): Table given below shows total people (male + female) live in five (P, Q, R, S, and T) different societies in the year 2020 and it also shows ratio of male to female in these five societies in year 2020. Read the data carefully and answer the questions.

Note: Neither any people left nor any people came to live in 2020.

Societies	Total people (male + female)	Ratio of male to female Male : Female
P	160	5:3
Q	220	15:7
R	240	11:13
S	200	3:2
T	210	11:10

Q131. Find the average number of females in societies Q, R and T?

- (a) 120 (b) 140 (c) 100
(d) 80 (e) 90

Q132. In the year 2021, 20% male from R left the society and no new people come in society R. If the ratio of male to female in 2021 in society R is 4:5, then find the number of females who left the society R in 2021?

- (a) 10 (b) 16 (c) 24
(d) 20 (e) 30

Q133. There is another society X in which number of people are 20% more than the number of people in society P. In society X there are some houses. In society X there are ten houses in which four people live in each house, ten house in which six people live in



each house, five house in which eight people live in each house and in remaining house there is two people live in each house. Find total number of houses in society X?

- (a) 51 (b) 67 (c) 82
(d) 98 (e) 47

Q134. Total number of females in society S is what percent more or less than total number of females in society T?

- (a) 15% (b) 20% (c) 25%
(d) 10% (e) 7.5%

Q135. The ratio of number of people in society T to that of in society N is 21:24 and number of males in society N is $66\frac{2}{3}\%$ of number of females in society N. Find the number of males in society N?

- (a) 84 (b) 36 (c) 54
(d) 96 (e) 72

Q136. Total number of males in 2021 in society P is equal to the average number of males in 2020 in societies Q and R and number of females in 2021 in society P is 10 less than the number of males in 2021 in that society.

Find the number of people in 2021 in society P?

- (a) 220 (b) 240 (c) 250
(d) 260 (e) 270

Directions (137-140): What approximate value should come in place of question mark (?) in the following questions?

Q137. $44.04 \div 3.97 \times 7.49 \div 2.54 + 3 = \sqrt{?}$

- (a) 6 (b) 36 (c) 24
(d) 1296 (e) 216

Q138.

$\sqrt{37.54\% \text{ of } 400.08 + 75.07\% \text{ of } 59.92} = ?$

- (a) 7 (b) 14 (c) 49
(d) 98 (e) 196

Q139. $(9.01)^3 + (7.94)^3 + 5.12 \times 17.95 = ?^3$

- (a) 11 (b) 15 (c) 13
(d) 10 (e) 14

Q140. $62.01\% \text{ of } ? + (24.04)^2 = (30.99)^2 - \sqrt{169.01}$

- (a) 660 (b) 600 (c) 640
(d) 720 (e) 780



WINNER INSTITUTE

India's Best Banking Institute

www.wiceindia.com Search on Google

-  Offline Classes
-  Online Classes
-  Test Series
-  Basic & Advance Batch



भारत में सबसे ज्यादा चयन करवानेवाली
मान्यताप्राप्त शिक्षण संस्था

☎ 99 22 41 6666 / 80 87 167 666

-  Mock Interview
-  1500 +
Recorded Videos
-  Study Material
-  Special Mains Batch

IBPS PO Mains (Memory Based Paper) Answer key

Q.1. B	Q.15. E	Q.29. B	Q.43. D	Q.57. D	Q.71. D	Q.85. C	Q.99. A	Q.113. B	Q.127. E
Q.2. B	Q.16. C	Q.30. E	Q.44. A	Q.58. A	Q.72. D	Q.86. D	Q.100. C	Q.114. B	Q.128. B
Q.3. E	Q.17. D	Q.31. D	Q.45. A	Q.59. E	Q.73. C	Q.87. C	Q.101. D	Q.115. C	Q.129. B
Q.4. D	Q.18. A	Q.32. A	Q.46. D	Q.60. B	Q.74. E	Q.88. B	Q.102. E	Q.116. C	Q.130. B
Q.5. D	Q.19. D	Q.33. D	Q.47. E	Q.61. C	Q.75. B	Q.89. C	Q.103. D	Q.117. D	Q.131. C
Q.6. D	Q.20. C	Q.34. E	Q.48. C	Q.62. B	Q.76. A	Q.90. D	Q.104. D	Q.118. A	Q.132. D
Q.7. C	Q.21. E	Q.35. D	Q.49. C	Q.63. C	Q.77. D	Q.91. B	Q.105. C	Q.119. B	Q.133. A
Q.8. E	Q.22. D	Q.36. B	Q.50. C	Q.64. D	Q.78. C	Q.92. D	Q.106. E	Q.120. A	Q.134. B
Q.9. D	Q.23. C	Q.37. D	Q.51. E	Q.65. B	Q.79. C	Q.93. C	Q.107. A	Q.121. E	Q.135. D
Q.10. B	Q.24. A	Q.38. A	Q.52. E	Q.66. B	Q.80. C	Q.94. A	Q.108. C	Q.122. A	Q.136. C
Q.11. E	Q.25. A	Q.39. B	Q.53. B	Q.67. A	Q.81. E	Q.95. C	Q.109. D	Q.123. C	Q.137. D
Q.12. E	Q.26. E	Q.40. E	Q.54. A	Q.68. B	Q.82. B	Q.96. C	Q.110. E	Q.124. D	Q.138. B
Q.13. B	Q.27. E	Q.41. E	Q.55. B	Q.69. E	Q.83. A	Q.97. D	Q.111. A	Q.125. A	Q.139. A
Q.14. C	Q.28. C	Q.42. C	Q.56. D	Q.70. B	Q.84. C	Q.98. A	Q.112. C	Q.126. E	Q.140. B



Puzzles

Directions (1-5): Study the following information carefully and answer the questions given below.

Seven persons P, Q, R, S, T, U and V are going to the dance class on seven different days from Monday to Sunday of the same week. Each person eats different chocolates viz. Perk, Twix, Gems, Bounty, Snickers, Galaxy and Aero. All the information is not necessarily in the same order.

S goes to the dance class on one of the days after Thursday. The one who eats Gems goes immediately after S. Only three persons go between the one who eats gems and V. As many persons go after V as before R. The one who eats Twix goes three days before R. Only one person goes between the one who eats Twix and P, who eats Aero. The one who eats perk goes immediately after P. T goes two days after the one who eats perk. The one who eats bounty goes immediately after U. Q neither goes before U nor eats galaxy.

1. Who among the following person goes to the dance class on Wednesday?

- a) V
- b) P
- c) Q
- d) U
- e) T

2. How many persons go between S and the one who eats Snickers?

- a) One
- b) Two
- c) Three
- d) Four
- e) No one

3. Four of the following five are alike in a certain way based on the given arrangement and thus form a group. Which one of the following does not belong to the group?

- a) PV
- b) SR
- c) UQ

- d) TS
- e) VU

4. R goes to the dance class on which of the following day?

- a) Monday
- b) Thursday
- c) Friday
- d) Sunday
- e) Saturday

5. Who among the following person goes two days before U?

- a) The one who eats Twix chocolates
- b) Q
- c) The one who goes immediately before V
- d) T
- e) The one who eats Gems

Directions (6-10): Study the following information carefully and answer the questions given below.

Fourteen persons are sitting in two parallel rows in such a way that there is an equal distance between adjacent persons. In row 1 A, B, C, D, E, F and G are seated and all of them are facing south. In row 2 M, N, O, P, Q, R and S are seated and all of them are facing north. Each person in row 1 faces exactly one person in row 2.

D sits fifth to the right of G. Only three persons sit between Q and the one who faces D. M sits second to the left of Q. O sits immediate left of M. Only one person sits between F and the one who faces O. B sits immediate left of F. The one who faces B sits fourth to the right of S. Only two persons sit between S and P. A faces one of the immediate neighbours of P. C sits fourth to the left of A. R doesn't sit at the end.

6. Who among the following person sits third to the left of R?

- a) The one who faces C
- b) S
- c) The one who sits second to the right of S
- d) P



e) O

7. The number of persons sitting to the right of E is one less than the number of persons sitting to the left of__.

- a) F
- b) D
- c) P
- d) B
- e) R

8. What is the position of Q with respect to O?

- a) Third to the right
- b) Fourth to the left
- c) Second to the left
- d) Immediate right
- e) None of these

9. How many persons sit between C and B?

- a) Four
- b) Two
- c) Three
- d) Five
- e) One

10. Which of the following statement(s) is/are true with respect to the final arrangement?

- I. E sits opposite to O
 - II. Only two persons sit to the left of Q
 - III. Both A and G are not immediate neighbours
- a) Only I
 - b) Only I and III
 - c) Only II
 - d) Only II and III
 - e) All I, II and III

Directions (11-15): Study the following information carefully and answer the questions given below.

Eight persons viz., K, L, M, N, O, P, Q and R are living in the four storey building, where the lowermost floor is numbered as one and the floor immediately above it is numbered as two and so on.

Note-I: Each floor has two type of flats viz., Flat A and Flat-B, where Flat A is to the west of flat B.

Note-II: Flat B of floor 2 is immediately above Flat B of floor 1 and immediately below Flat B of floor 3 and so on. Similarly, Flat A of floor 2 is immediately above Flat A of floor 1 and immediately below Flat A of floor 3 and so on.

Note-III: The area of each flat is same.

Note-IV: Only two persons live on each floor and only one person lives in each flat.

N lives in flat B on an odd numbered floor. R lives immediately above N, both are living in different type of flats. As many floors below R as above O. No one lives to the east of O, who lives on the adjacent floor of M. Only one floor is between K and M, who lives on the same type of flat as R. P lives below K, both are living in different type of flats. L lives two floors above P. Q doesn't live on the topmost floor.

11. Who among the following person lives two floors below K?

- a) P
- b) The one who lives on the same floor as N
- c) L
- d) The one who lives immediately below the flat of N
- e) R

12. Four of the following five are alike in a certain way based on the given arrangement and thus form a group. Who among the following does not belong to the group?

- a) R
- b) Q
- c) L
- d) M
- e) K

13. In which direction L lives with respect to K?

- a) North
- b) South west
- c) West
- d) North east
- e) South east

14. Who among the following persons live on the same floor?

- a) L and O



- b) P and N
- c) K and M
- d) O and K
- e) R and K

15. Q lives on which of the following floor and flat?

- a) Floor 2, Flat A
- b) Floor 3, Flat B
- c) Floor 1, Flat, B
- d) Floor 2, Flat B
- e) Floor 3, Flat A

Directions (16-20): Study the following information carefully and answer the questions given below.

Eight persons viz., R, S, T, U, V, W, X, and Y are sitting around a circular table in such a way that four of them are facing the centre while four are facing away from the centre but not necessarily in the same order.

W sits second to the left of R, where both of them face different directions. Two persons sit between W and S, who doesn't sit adjacent to R. Y sits immediate right of S and second to the right of U, who faces towards the centre. T sits immediate left of Y. One person sits between T and X, who faces the same direction as R. V sits second to the right of X.

16. Who among the following person sits second to the left of V?

- a) T
- b) W
- c) The one who sits second to the right of R
- d) X
- e) The one who sits immediate right of Y

17. What is the position of X with respect to R?

- a) Third to the right
- b) Immediate left
- c) Second to the right
- d) Second to the left
- e) Fourth to the right

18. Who among the following person sits immediate right of W?

- a) The one who sits second to the right of S
- b) V
- c) U
- d) S
- e) The one who sits opposite to R

19. If Y is related to V and R is related to T in a certain way, then who among the following person is related to W?

- a) U
- b) X
- c) V
- d) Y
- e) None of these

20. How many persons sit between V and T?

- a) Two
- b) One
- c) Four
- d) Three
- e) No one

Directions (21-25): Study the following information carefully and answer the given questions.

Eight persons – M, N, O, P, Q, R, S and T are sitting in a linear row and facing the north direction.

Q sits fourth to the right of M, where neither of them sits at the extreme end. S sits immediate left of Q. Only three persons sit between S and O. R sits second to the right of O. As many persons sit between R and M as between S and T. Only two persons sit between T and N, who is not an immediate neighbour of P.

21. As many persons sit to the left of P as to the right of __.

- a) O
- b) T
- c) M
- d) Q
- e) N

22. If all the persons are made to sit in the alphabetical order from the left end, then how many persons remain unchanged in their position?



- a) No one
- b) Four
- c) Three
- d) One
- e) Two

23. What is the position of N with respect to S?

- a) Immediate right
- b) Immediate left
- c) Third to the left
- d) Second to the right
- e) Second to the left

24. Which of the following statement(s) is/are true as per the given arrangement?

- I. Only two persons sit to the right of Q
 - II. Both O and M are immediate neighbours
 - III. S sits second to the right of R
- a) Only III
 - b) Only I and III
 - c) Only II and III
 - d) Only I
 - e) All I, II and III

25. Who among the following person sits immediate right of P?

- a) R
- b) The one who sits immediate left of M
- c) S
- d) T
- e) The one who sits second to the right of Q

Directions (26-30): Study the following information carefully and answer the given questions.

Eight persons – A, B, C, D, E, F, G and H are sitting around a square table in such a way that four of them are sitting at the corners and facing away from the centre while four of them are sitting in the middle of the sides and facing towards the centre.

D sits second to the right of H, who doesn't sit at the corner of the table. A is an immediate neighbour of D. F sits second to the left of A. Only three persons sit between F and B. As many persons sit between B and H as between F and C,

who sits second to the left of E. G doesn't sit immediate left of E.

26. Who among the following person sits opposite to D?

- a) The one who sits second to the right of C
- b) F
- c) The one who sits second to the left of G
- d) A
- e) G

27. If F is related to A and B is related to G in a certain way, then in the same way who among the following person is related to H?

- a) A
- b) G
- c) C
- d) E
- e) D

28. What is the position of F with respect to D?

- a) Immediate right
- b) Second to the left
- c) Third to the right
- d) Immediate left
- e) Fourth to the right

29. Who among the following person does not sit at the corner of the table?

- a) F
- b) A
- c) E
- d) G
- e) B

30. Which of the following pairs of persons sit immediate right of each other?

- a) D and B
- b) F and C
- c) H and E
- d) F and E
- e) G and A

Directions (31-35): Study the following information carefully and answer the given questions.



Six persons – A, B, C, D, E and F are working in a bank at different designations such as General Manager (GM), Assistant General Manager (AGM), Senior Manager (SM), Manager, Probationary Officer (PO), and Clerk. The designations are given in decreasing order such as General Manager (GM) is the senior most designation and Clerk is the junior most designation. Each person likes different currencies viz. Rupee, Dollar, Euro, Pounds, Rial and Dinar.

Only one person is designated between the one who likes Dollar and B, who is not senior to the PO. The one who likes Euro is immediately senior to B. Only two persons are designated between F and the one who likes Euro. As many persons senior to F as junior to A. Only three persons are designated between A and the one who likes Rial. C is two persons junior to the one who likes Rial. D is immediately junior to the one who likes Rupee. Neither F nor B likes Pounds.

31. Who among the following person likes Dinar?

- a) F
- b) The one who is immediately junior to B
- c) C
- d) The one who is designated as PO
- e) D

32. The number of persons senior to C is one less than the number of persons junior to __.

- a) F
- b) D
- c) A
- d) B
- e) E

33. Who among the following persons are junior most and senior most designated persons respectively?

- a) B, E
- b) C, D
- c) F, A
- d) F, C
- e) A, F

34. How many persons are designated between the one who likes Pounds and the one who likes Rupee?

- a) Three
- b) One
- c) Four
- d) Two
- e) None

35. Which of the following combination is true?

- a) E-Dollar
- b) C-Dinar
- c) F-Rial
- d) A-Euro
- e) B-Rupee

Directions (36-40): Study the following information carefully and answer the given questions.

Eight people – P, Q, R, S, T, U, V and X bought the Laptop on two different dates either 6th or 21st of four different months viz. January, April, July and September of the same year.

S bought the laptop in the month having an odd number of days. P bought three people after S. U bought immediately before P. Only three people bought between U and X. As many people bought before X as after Q. Only one person bought between Q and R. Only two people bought between R and V. T was not bought the laptop on an even numbered date.

36. Four of the following five are alike in a certain way based on the given arrangement and thus form a group. Which one of the following does not belong to the group?

- a) T
- b) U
- c) R
- d) Q
- e) P

37. If T is related to V and S is related to R in a certain way, then in the same way who among the following person is related to Q?

- a) V



- b) R
- c) P
- d) U
- e) None of these

38. If all the persons bought the laptop in the reverse alphabetical order from January 6th, then who among the following person remain unchanged in their position?

- a) X
- b) S
- c) P
- d) Both a and c
- e) Both b and c

39. Which of the following statements is/are not true as per the given arrangement?

- I. S bought two people after V
- II. Only three people bought between Q and T
- III. P bought the laptop on September 6

- a) Only I and III
- b) Only III
- c) Only II and III
- d) Only I
- e) All I, II and III

40. R bought the laptop in which of the following month and date?

- a) July 21
- b) January 21
- c) April 21
- d) April 6
- e) July 6

Direction (41-45): Study the following information carefully and answer the given questions.

A certain number of persons are sitting in a linear row facing north. U, who sits third from one of the extreme ends and sits second to the left of Y.

Only ten persons sit between Y and M. Only six persons sit between U and V. B sits to the immediate right of V. As many persons sit between V and M as between M and O. I sits to the immediate left of O. P sits second to the right of I and sits at one of the extreme ends.

41. How many persons are sitting in the row?

- a) 21
- b) 22
- c) 23
- d) 24
- e) 25

42. As many persons sit between Y and B as between O and __.

- a) I
- b) M
- c) P
- d) U
- e) B

43. Who among the following person sits fifth to the left of I?

- a) Y
- b) The one who sits second to the left of U
- c) P
- d) U
- e) The one who sits fifth to the right of B

44. How many persons are sitting between V and P?

- a) 9
- b) 10
- c) 11
- d) 12
- e) 13

45. Which of the following statements is/are TRUE as per the given arrangement?

- a) As many persons sit to the right of U as to the left of I
- b) Odd number of persons are sitting between M and P
- c) Only five persons sit to the right of Y.
- d) Both a and b
- e) Both a and c

Direction (46-50): Study the following information carefully and answer the given questions.

Eight persons - E, F, G, H, I, J, K and L are living on different floors of an eight storey building where the lowermost floor is numbered one and the

floor immediately above it is numbered two and so on. No two persons live on the same floor.

J lives on an odd numbered floor and lives three floors above E. As many floors above E as below K. Only three persons live between K and L. H lives immediately above L. As many persons live between E and L as between K and G. F lives two floors below G. More than two floors are between F and I.

46. Who among the following person lives four floors above I?

- a) F
- b) The one who lives exactly between F and L.
- c) K
- d) The one who lives immediately above H
- e) L

47. If all the persons are living in alphabetical order from top to bottom, then how many persons are unchanged from their position?

- a) No one
- b) One
- c) Two
- d) Three
- e) More than three

48. If K and H are interchanged their position, similarly E and G are interchanged their position, then how many persons are living between H and G?

- a) No one
- b) One
- c) Two
- d) Three
- e) More than three

49. What is the sum of the floor numbers of F and L?

- a) 6
- b) 3
- c) 9
- d) 12
- e) 13

50. What is the position of K with respect to J?

- a) Immediately above
- b) Three floors below

- c) Five floors above
- d) Two floors below
- e) None of these

Direction (51-55): Study the following information carefully and answer the given questions.

Six persons – I, J, K, L, M, and N joined different IT Companies- TCS, HCL, Wipro, CTS, Oracle and IBM in different months –January, March, April, June, August and November of the same year.

No two persons joined in the same month. M, who doesn't work in Oracle and joined in the month which has an odd number of days. The one who works in TCS joined three months after M. The number of persons joined after I is two less than the number of persons joined before the one who works in TCS. Only three persons joined between I and the one who works in HCL. K joined two persons after the one who works in HCL. As many persons joined between K and I as between the one who works in TCS and L, who works in CTS. The one who works in Wipro joined before the one who works in IBM but joined after J. K doesn't work in IBM.

51. Which of the following combination is true?

- a) J-March
- b) L-August
- c) N-June
- d) I-November
- e) K-January

52. Who among the following person joined the company immediately after N?

- a) L
- b) The one who works in Wipro
- c) K
- d) J
- e) The one who works in IBM

53. How many months gap between the months in which I and K joined?

- a) One
- b) Two
- c) Three

- d) More than three
- e) None

54. Who among the following persons works in Wipro?

- a) J
- b) I
- c) N
- d) M
- e) None of these

55. As many persons joined the company between J and N as between L and __.

- a) M
- b) K
- c) J
- d) I
- e) N

Direction (56-60): Study the following information carefully and answer the given questions.

Eight persons - E, F, G, H, I, J, K and L have different pets viz., Cat, Dog and Parrot in their house. At least two persons but not more than three persons have the same pet.

F and I have the same pet but not has Dog. E and G have different pets but both of them neither has the same pet as F nor has Cat. L and J have the same pet but not the same pet as E. H neither has the same pet as I nor has parrot.

56. Which of the following pet does K have?

- a) Dog
- b) Parrot
- c) Cat
- d) Either a or b
- e) Either a or c

57. Which of the following statements is/are true based on the given information?

- a) E has dog in his house
- b) G and J have the same pet in their house
- c) L and K have different pets in their house
- d) All the given statements are true
- e) All the given statements are false

58. Which of the following combination is definitely true?

- a) K-Cat
- b) G-Dog
- c) L-Parrot
- d) H-Cat
- e) I-Parrot

59. Who among the following persons has Parrot in his house?

- a) F
- b) G
- c) E
- d) K
- e) I

60. If H is related to dog and I is related to Cat in a certain way, then in the same way who among the following person is related to Parrot?

- a) E
- b) K
- c) F
- d) H
- e) J

Directions (61-65): Study the following information carefully and answer the given questions.

Six persons - E, F, G, H, I and J are sitting around a circular table facing the centre. Each of them has different number of coins viz. 10, 20, 30, 40, 50 and 60. All the information is not necessarily in the same order.

H sits second to the left of the one who has 20 coins. G has 10 coins and sits adjacent to H, who has 40 coins. E sits exactly opposite to the one who has 40 coins. Only two persons sit between F and I. J has 20 coins more than E. F has less coins than H.

61. Who among the following person has the highest number of coins?

- a) J
- b) The one who sits second to the left of F
- c) E
- d) The one who sits immediate right of J



e) F

62. How many persons sit between J and H when counted from the left of H?

- a) One
- b) Three
- c) None
- d) Four
- e) Two

63. What is the total number of coins had by E and I?

- a) 80
- b) 90
- c) 70
- d) 50
- e) 60

64. Which of the following combination is true based on the given information?

- a) F-50
- b) J-60
- c) I-30
- d) F-20
- e) None of these

65. What is the position of G with respect to the one who has 60 coins?

- a) Third to the right
- b) Fifth to the left
- c) Second to the right
- d) Fifth to the right
- e) Third to the left

Directions (66-70): Study the following information carefully and answer the given questions.

Six trains - M, N, O, P, Q and R are standing in a linear row and facing south. They are going to different destinations such as Delhi, Mumbai, Pune, Bihar, Nagpur, and Assam. All the information is not necessarily in the same order.

Only two trains are standing between N and O. The train which goes to Nagpur is standing immediate right of O. Only one train is standing between the one which goes to Nagpur and M. Q is standing third to the left of P and goes to

Mumbai. One of the trains which stands adjacent to R goes to Delhi. Neither M nor R goes to Pune. The train which goes to Assam does not stand towards the left of the train which goes to Pune.

66. Which of the following train is not standing towards the right of the one which goes to Bihar?

- a) R
- b) O
- c) Q
- d) P
- e) N

67. Which among the following trains are not standing between R and M?

- I. O
 - II. N
 - III. Q
 - IV. P
- a) Only II
 - b) Only III
 - c) Only III and IV
 - d) Only I and II
 - e) Only II and III

68. What is the destination of the train which is standing third to the left of R?

- a) Pune
- b) Bihar
- c) Delhi
- d) Nagpur
- e) None of these

69. If one of the adjacent trains of P is O, then which of the following train is another one?

- a) Q
- b) N
- c) M
- d) R
- e) None

70. The train which is standing exactly between M and P, goes to __.

- a) Pune
- b) Assam
- c) Nagpur
- d) Mumbai



e) Delhi

Directions (71-75): Study the following information carefully and answer the given questions.

Nine boxes - A, B, C, D, E, F, G, H and I are kept one above another in a single stack.

Only four boxes are kept between H and B. Box B is kept two boxes above E. Only two boxes are kept between E and C. Neither D nor A is kept adjacent to H. Box A is kept three boxes below D. As many boxes kept above A as below I. Box G is not kept below I.

71. Which of the following box is kept second from the top?

- a) H
- b) E
- c) C
- d) G
- e) I

72. As many boxes kept between I and A as between F and ____

- a) H
- b) C
- c) G
- d) B
- e) I

73. Four of the following five are alike in a certain way based on the given arrangement and thus form a group. Which one of the following does not belong to the group?

- a) HI
- b) DB
- c) AF
- d) CA
- e) IB

74. If the position of boxes I and E is interchanged, then how many boxes are kept below box I?

- a) As many boxes kept above G
- b) Two
- c) As many boxes kept between D and C
- d) Four

e) Three

75. What is the position of box H with respect to box I?

- a) Three boxes below
- b) Three boxes above
- c) Two boxes above
- d) Immediately below
- e) Four boxes above

Directions (76-80): Study the following information carefully and answer the given questions.

Seven people - P, Q, R, S, T, U and W bought the shares of a company in seven different years viz. 2002, 2005, 2006, 2008, 2011, 2017 and 2020. No two people bought the shares in the same year.

Q bought the shares six years after R. Only three people bought between R and W. The number of people bought the shares after W is one more than the number of people bought the shares before S. The difference between the years in which S and U bought the shares is equal to the difference between the years in which R and T bought the shares.

76. Who among the following person bought the shares in 2017?

- a) Q
- b) W
- c) U
- d) T
- e) S

77. P bought the shares ____ years after R.

- a) Two
- b) Three
- c) One
- d) Five
- e) Four

78. How many people bought the shares between U and W?

- a) As many people bought before S
- b) Three
- c) As many people bought between R and S
- d) Two



e) Four

79. Which of the following statement is true based on the given information?

- a) R bought the shares after S
- b) U bought the shares in 2017
- c) T bought immediately before U
- d) Only three people bought before W
- e) Q bought three years before S

80. Four of the following five are alike in a certain way based on the given arrangement and thus form a group. Which one of the following does not belong to the group?

- a) R
- b) W
- c) U
- d) Q
- e) P

Directions (81-85): Study the following information carefully and answer the given questions.

Six persons - A, B, C, D, E, and F bought the watch in different months- January, March, April, July, September and December of the same year. Each of them likes different brands of watches- Timex, Rolex, Casio, Titan, Sonata, and Boat.

The one who likes Rolex bought three months after A. The number of persons bought the watch after A is one less than the number of persons bought the watch before C, who neither likes Sonata nor Timex. Only two months are between the months in which C and the one who likes Boat bought the watch. E bought two persons before the one who likes Boat. Only one person bought between D and the one who likes Sonata. Less than two months between the months in which the one who likes Casio and F bought the watch.

81. Who among the following person likes Titan watch?

- a) D
- b) C
- c) B
- d) E
- e) F

82. Who among the following person bought the watch in December?

- a) A
- b) The one who likes Timex watch
- c) C
- d) E
- e) The one who likes Boat watch

83. Which of the following statements is/are not false as per the given arrangement?

- a) B bought the watch in the month which has an even number of days
- b) Only two months between the months in which F and C bought the watch
- c) No one bought the watch before the one who likes Casio
- d) All the given statements are true
- e) All the given statements are false

84. Who among the following person bought the watch four months after the one who likes Timex watch?

- a) B
- b) A
- c) E
- d) C
- e) D

85. As many persons bought the watch before the one who likes Timex as after the one who likes _ watch

- a) Casio
- b) Rolex
- c) Boat
- d) Titan
- e) Sonata

Directions (86-90): Study the following information carefully and answer the given questions.

Eight persons - I, J, K, L, M, N, O and P are sitting around a circular table in such a way that some of them are facing towards the centre while some of them are facing away from the centre.

Note: Consecutive alphabetically named persons doesn't sit together. I doesn't face L and his immediate neighbours are facing the opposite



direction to him. I sits third to the left of O and both of them are facing opposite directions. Two persons sit between O and P. J and P are sitting immediate left of each other. The number of persons sitting between J and M is one less than the number of persons sitting between M and K, when counted from the left of both J and K. N faces the opposite direction of L.

86. Four of the following five are alike in a certain way based on the given arrangement and thus form a group. Which one of the following does not belong to the group?

- a) KL
- b) IM
- c) ON
- d) JP
- e) ML

87. What is the position of N with respect to M?

- a) Second to the left
- b) Sixth to the right
- c) Fifth to the left
- d) Second to the right
- e) Fourth to the right

88. If one of the neighbours of J is P, then who among the following is the second neighbour?

- a) M
- b) L
- c) N
- d) O
- e) None of these

89. Who among the following person sits third to the left of L?

- a) N
- b) The one who sits to the immediate left of P
- c) I
- d) K
- e) The one who sits opposite to O

90. In which of the following option, first person sits second to the right of the second person?

- a) IK
- b) NO
- c) PL

- d) MJ
- e) PI

Directions (91-95): Study the following information carefully and answer the given questions.

A certain number of persons are sitting in a linear row facing north.

Z sits to the immediate right of M, who sits fourth from one of the extreme ends. Only eight persons sit between Z and H. P sits third to the left of H. The number of persons sitting to the left of P is two less than the number of persons sitting to the right of C, where only one person sits between them. D sits second to the left of C. Only seven persons sit between D and R. Not more than two persons sit to the right of I, who sits four places away from R.

91. As many persons sit between I and __ as between C and __ respectively.

- a) P, R
- b) H, M
- c) D, Z
- d) R, H
- e) M, D

92. If A sits exactly between Z and R, then which of the following statements is/are true with respect to the final arrangement?

- a) C sits to the immediate right of A
- b) Only four persons sit between A and H
- c) M sits sixth to the left of A
- d) Both a and b
- e) Both a and c

93. Who among the following person sits fifth to the right of D?

- a) P
- b) H
- c) R
- d) C
- e) Not known

94. How many persons are sitting between P and I?

- a) Six



- b) Eight
- c) Five
- d) Seven
- e) Nine

95. How many persons are sitting in a row?

- a) 19
- b) 20
- c) 21
- d) 22
- e) 23

Directions (96-100): Study the following information carefully and answer the given questions.

Six persons - P, Q, R, S, T and U are living on different floors of a 6-storey building where the lowermost floor is numbered one and the floor immediately above it is numbered two and so on. No two persons live on the same floor. Each of them studied different courses-EEE, ECE, CS, IT, MBA, and MCA.

U lives on an odd-numbered floor and two floors above the one who studied IT. The number of persons living above the one who studied IT is two more than the number of persons living below P. Only one person lives between P and the one who studied MCA. The one who studied MBA lives three floors below Q. Neither U nor T studied MBA. The one who studied EEE lives below S but lives above T. R and the one who studied ECE are living on the adjacent floors. Neither Q nor S studied CS.

96. Which of the following combination is true?

- a) Q-MBA
- b) R-EEE

- c) T-MCA
- d) U-ECE
- e) P-IT

97. Who among the following person lives two floors below the one who studied EEE?

- a) P
- b) The one who studies MCA
- c) T
- d) R
- e) The one who lives three floors below S

98. What is the difference between the floor number of the person who studied MCA and IT?

- a) 4
- b) 1
- c) 5
- d) 3
- e) 2

99. If Q is related to the one who studies ECE, U is related to the one who studies IT in a certain way, then who among the following person is related to the one who studies CS?

- a) R
- b) S
- c) Q
- d) T
- e) U

100. Who among the following person studied IT?

- a) S
- b) Q
- c) T
- d) R
- e) P



ANSWER

Q.1. D	Q.11. D	Q.21. E	Q.31. D	Q.41. C	Q.51. C	Q.61. D	Q.71. D	Q.81. B	Q.91. B
Q.2. A	Q.12. C	Q.22. A	Q.32. B	Q.42. B	Q.52. E	Q.62. A	Q.72. B	Q.82. E	Q.92. C
Q.3. C	Q.13. B	Q.23. D	Q.33. E	Q.43. E	Q.53. C	Q.63. B	Q.73. E	Q.83. C	Q.93. E
Q.4. E	Q.14. E	Q.24. C	Q.34. C	Q.44. D	Q.54. D	Q.64. D	Q.74. A	Q.84. C	Q.94. D
Q.5. C	Q.15. D	Q.25. B	Q.35. A	Q.45. A	Q.55. B	Q.65. C	Q.75. C	Q.85. D	Q.95. C
Q.6. C	Q.16. E	Q.26. A	Q.36. B	Q.46. D	Q.56. E	Q.66. C	Q.76. D	Q.86. C	Q.96. D
Q.7. D	Q.17. B	Q.27. D	Q.37. D	Q.47. A	Q.57. D	Q.67. E	Q.77. E	Q.87. D	Q.97. E
Q.8. A	Q.18. A	Q.28. C	Q.38. E	Q.48. E	Q.58. C	Q.68. B	Q.78. A	Q.88. B	Q.98. C
Q.9. E	Q.19. C	Q.29. C	Q.39. A	Q.49. C	Q.59. B	Q.69. D	Q.79. C	Q.89. E	Q.99. B
Q.10. B	Q.20. D	Q.30. B	Q.40. C	Q.50. E	Q.60. E	Q.70. A	Q.80. B	Q.90. E	Q.100. C

EXPLANATION

(01-05)

Days	Persons	Chocolates
Monday	P	Aero
Tuesday	V	Perk
Wednesday	U	Twix
Thursday	T	Bounty
Friday	S	Galaxy
Saturday	R	Gems
Sunday	Q	Snickers

(06-10)

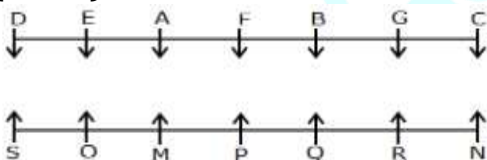

(11-15)

Floor	Flat A	Flat B
4	R	K
3	L	N
2	M	Q
1	P	O

(16-20)

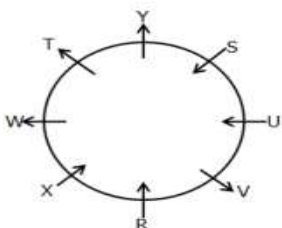

(21-25)

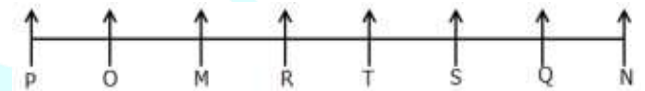

(26-30)

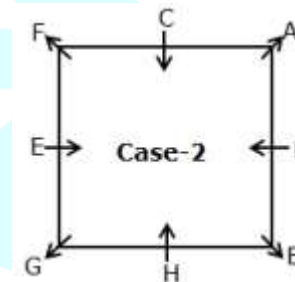

(31-35)

Designation	Person	Currency
General Manager (GM)	F	Rupee
Assistant General Manager (AGM)	D	Rial
Senior Manager (SM)	E	Dollar
Manager	C	Euro
Probationary Officer (PO)	B	Dinar
Clerk	A	Pounds

(36-40)

Month	Date	People
January	6	V
	21	T
April	6	X
	21	R
July	6	S
	21	Q
September	6	U
	21	P



(41-45)

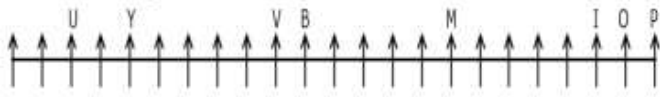

(46-50)

Floors	Persons
8	G
7	K
6	F
5	J
4	H
3	L
2	E
1	I

(51-55)

Months	Persons	Company
January	J	HCL
March	M	Wipro
April	K	Oracle
June	N	TCS
August	I	IBM
November	L	CTS

(56-60)

Dog	Parrot	Cat
E, H, (K)	G, L, J	F, I, (K)

(61-65)

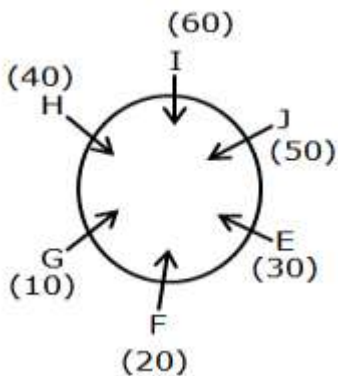

(66-70)

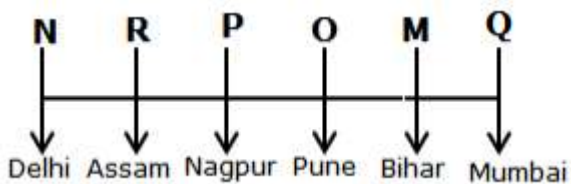

(71-75)

Boxes
H
G
I
D
C
B
A
E
F

(76-80)

Years	Company
2002	R
2005	S
2006	P
2008	Q
2011	W
2017	T
2020	U

(81-85)

Months	Persons	Watches
January	D	Casio
March	F	Timex
April	A	Sonata
July	E	Rolex
September	C	Titan
December	B	Boat

(86-90)

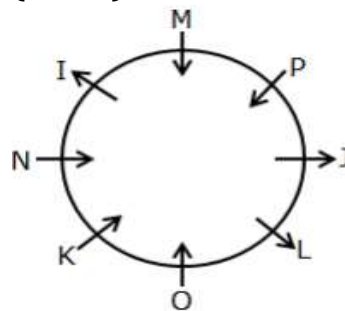

(91-95)

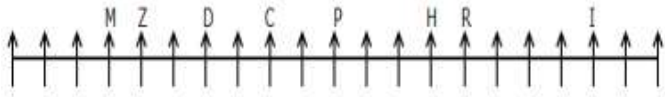

(96-100)

Floors	Persons	Courses
6	S	MCA
5	Q	EEE
4	P	CS
3	U	ECE
2	R	MBA
1	T	IT



Mr. Abhay Satyaki
Ex. Andhra Bank Manager



**Offline
Classes**



**Online
Classes**



**Study
Material**



**Basic &
Advance Batches**



**Mock
Interviews**



**1500 +
Recorded Videos**



**Special
Mains Batches**



**Test
Series**



Ms. Mrudul Meshram
Ex. SBI Manager

Get trained from Ex Bankers...

Focused guidance from accomplished Educators...

Train yourself for definite Success & Selection...



WINNER INSTITUTE
India's Best Banking Institute



99 22 41 6666 / 99 23 125 666



Puzzles

Direction (1-5): Study the following information carefully and answer the given questions.

A certain number of persons are sitting in a linear row and facing south.

Only three persons sit between M and T. J sits third to the right of T. O sits fifth to the right of J. Only four persons sit between O and K, who sits third from one of the extreme ends. W sits six places away from K. X sits third to the left of W.

As many persons sit to the left of X as to the right of X.

1. How many persons are sitting in the row?

- a) 19
- b) 20
- c) 24
- d) 23
- e) 25

2. If L sits exactly between M and T, then who among the following sits second to the left of L?

- a) J
- b) The one who sits fourth to the left of T
- c) X
- d) The one who sits immediate right of W
- e) K

3. Who among the following sits fourth to the right of J?

- a) W
- b) M
- c) T
- d) O
- e) K

4. What is the position of M from the left end of the row?

- a) 20th
- b) 16th
- c) 8th
- d) 6th
- e) 4th

5. How many persons sit between X and T?

- a) None

- b) One
- c) Three
- d) Four
- e) Five

Direction (6-10): Study the following information carefully and answer the given questions.

Six persons - M, N, O, P, Q and R live on three different floors of a three storey building where the lowermost floor is numbered one and the floor immediately above it is numbered two and so on. They are from different states viz., Assam, Bihar, Punjab, Kerala, Haryana and Gujarat.

Note-I: Each floor has two flats viz., Flat-A and Flat-B, where Flat A is to the west of flat B.

Note-II: Flat B of floor number two is immediately above Flat B of floor number one and so on.

Similarly, Flat A of floor number two is immediately below Flat A of floor number three and so on.

Note-III: Area of each flat on each floor is same.

Note-IV: Only one person lives in each flat and only two persons live on each floor.

P lives two floors above the one who is from Punjab, where both of them live in different type of flats. P and O are living on the same floor. The one who is from Bihar lives immediately below O's flat. M is neither from Bihar nor from Gujarat.

M lives to the east of R. N lives below the one who is from Haryana, where both are not living in the same flat. No one lives to the east of N. The one who is from Gujarat lives to the south of the one who is from Assam, who lives in a different type of flat of the one who is from Kerala.

6. Who among the following person is from Bihar?

- a) O
- b) R
- c) P
- d) Q
- e) N



7. How many persons live below R?

- a) No one
- b) Two
- c) Four
- d) Either b or c
- e) Cannot be determined

8. Who among the following person lives in Flat A?

- a) N
- b) O
- c) The one who is from Punjab
- d) The one who is from Gujarat
- e) M

9. P lives on which of the following flat and floor?

- a) Flat B, 3rd floor
- b) Flat A, 1st floor
- c) Flat A, 3rd floor
- d) Flat B, 2nd floor
- e) Flat A, 2nd floor

10. Who among the following person lives to the south of Q?

- a) P
- b) R
- c) O
- d) M
- e) N

Direction (11-15): Study the following information carefully and answer the given questions.

Eight persons - I, J, K, L, M, N, O and P are sitting around a rectangular table in such a way that four of them are sitting at the corners and facing away from the centre while four of them are sitting in the middle of the sides and facing the centre.

J sits second to the left of P. Only three persons sit between P and K. O is an immediate neighbour of K. O doesn't sit immediate left of J. I sits opposite to L, who is an immediate neighbour of M. N does not face away from the centre.

11. Who among the following person faces O?

- a) The one who sits immediate left of J
- b) M

- c) The one who sits immediate left of P
- d) K
- e) None of these

12. How many persons sit between N and K, when counted from the right of K?

- a) None
- b) Five
- c) Four
- d) Two
- e) One

13. What is the position of M with respect to P?

- a) Second to the right
- b) Immediate left
- c) Immediate right
- d) Second to the left
- e) Third to the left

14. Who among the following person sits second to the right of I?

- a) K
- b) J
- c) N
- d) P
- e) O

15. Four of the following are alike in a certain way based on the given arrangement and thus form a group. Which one of the following does not belong to the group?

- a) K
- b) L
- c) M
- d) P
- e) J

Direction (16-20): Study the following information carefully and answer the given questions.

Eight persons - P, Q, R, S, T, U, V and W are working in the air force at different designations such as Air Chief Marshal, Air Commodore, Group Captain, Wing Commander, Squadron Leader, Flight Lieutenant, Flying Officer and Air Craftsman. The designations are given in decreasing order such as the Air Chief Marshal is the senior most designation



and the Air Craftsman is the junior most designation.

S is designated senior to Group Captain. Only three persons are designated between S and W. Q is two persons senior to W. V is senior to W but junior to U, who doesn't work as Group Captain. No one is designated between P and T, who is senior to R. T doesn't work as Flying Officer.

16. Who among the following person works as Flight Lieutenant?

- a) The one who is immediately senior to W
- b) T
- c) Q
- d) The one who is immediately junior to S
- e) R

17. How many persons are junior to V?

- a) None
- b) One
- c) Four
- d) Three
- e) Two

18. As many persons senior to P as junior to

- ___.
- a) S
 - b) W
 - c) R
 - d) U
 - e) Q

19. Four persons are designated between ___ and

- ___.
- a) S, T
 - b) Q, P
 - c) R, U
 - d) V, S
 - e) W, P

20. R works in which of the following designation?

- a) Squadron Leader
- b) Air Commodore
- c) Wing Commander
- d) Flying Officer
- e) Air Craftsman

Directions (21-25): Study the following information carefully and answer the given questions.

Nine persons – D, E, F, G, H, I, J, K and L went to the movie in nine different months viz. January, March, April, June, July, September, October, November and December of the same year.

H went to the movie in the month having 30 days but after July. Only two persons went between H and F. L went immediately before F. As many persons went before L as after D. Only three persons went between D and G. K went to the movie in the adjacent month of G. Only two months are between the months in which K and I went to the movie. E went to the movie at least three months before J.

21. How many persons went to the movie after H?

- a) As many persons went between E and G
- b) One
- c) Four
- d) As many persons went before G
- e) Five

22. E went to the movie in which of the following month?

- a) October
- b) January
- c) June
- d) April
- e) December

23. If L is related to June and K is related to October in a certain way, then in the same way who among the following person is related to April?

- a) I
- b) F
- c) H
- d) G
- e) E

24. The number of persons went to the movie before K is twice the number of persons went to the movie after___.

- a) F
- b) L



- c) I
- d) J
- e) H

25. Who among the following person went to the movie in December?

- a) J
- b) L
- c) F
- d) K
- e) I

Directions (26-30): Study the following information carefully and answer the given questions.

Seven persons – R, S, T, U, V, W and X are taking leave in the 10th class on seven different days from Monday to Sunday of the same week.

No two persons take leave on the same day. T takes leave three days before W, who takes leave neither on Sunday nor on Friday. Only three persons take leave between T and R. As many persons take leave after R as before V. Only two persons take leave between V and X. U takes leave immediately after X. More than two persons take leave between U and S.

26. On which of the following day does V take leave?

- a) Wednesday
- b) Tuesday
- c) Friday
- d) Saturday
- e) Monday

27. How many persons take leave before R?

- a) One
- b) Five
- c) Three
- d) Four
- e) Six

28. Four of the following five are alike in a certain way based on the given arrangement and thus form a group. Which one of the following does not belong to the group?

- a) TS
- b) XV

- c) UX
- d) XR
- e) WR

29. Who among the following person takes leave on Saturday?

- a) The one who takes leave immediately before S
- b) V
- c) S
- d) U
- e) The one who takes leave two days after W

30. Which of the following statement(s) is/are TRUE as per the given arrangement?

- A. R takes leave on Sunday
- B. Both V and W take leave on consecutive days
- C. Only two persons take leave before T
- a) Only A and C
- b) Only A and B
- c) Only B
- d) Only C
- e) All, A, B and C

Directions (31-35): Study the following information carefully and answer the given questions.

Eight persons – D, E, F, G, H, I, J and K are sitting in a linear row in such a way that four of them are facing north while the other four facing south.

F sits fourth to the left of J, where neither of them sits at the extreme ends. D sits second to the right of J and faces north. Only two persons sit between D and K. As many persons sit to the right of K as to the left of H, who faces the opposite direction as J. E sits immediate right of H. The immediate neighbours of E are facing the opposite direction to each other. I sits second to the left of E, who doesn't face south.

31. Who among the following person sits second to the right of G?

- a) J
- b) The one who sits immediate left of J
- c) I
- d) E
- e) The one who sits second to the right of F



32. As many persons sit to the left of E as to the right of ____.

- a) D
- b) H
- c) C
- d) F
- e) J

33. What is the position of E with respect to I?

- a) Immediate left
- b) Third to the left
- c) Second to the left
- d) Fifth to the right
- e) Second to the right

34. How many persons sit between F and G?

- a) Four
- b) Three
- c) Five
- d) six
- e) No one

35. ____ and ____ are facing in the same direction to each other.

- a) F, K
- b) J, G
- c) I, E
- d) D, E
- e) K, J

Directions (36-40): Study the following information carefully and answer the given questions.

Six persons – F, G, H, I, J and K live on six different floors of a six-storey building where the lowermost floor is numbered 1 and the floor immediately above it is numbered 2 and so on. Each person likes different colours viz. Red, Blue, Pink, White, violet and green.

The one who likes Red lives on an odd numbered floor. Only two persons live between H and the one who likes red. The one who likes violet lives immediately below H. As many persons live above the one who likes violet as below the one who likes blue. K lives two floors below the one who likes blue. Only two persons live between K and F. I, who likes white and lives immediately above the one

who likes Pink. G doesn't live above the one who likes green.

36. J lives on ____ floor and likes ____ colour.

- a) 5th, Blue
- b) 1st, White
- c) 3rd, Violet
- d) 6th, Pink
- e) 4th, Green

37. What is the position of H with respect to the one who likes Green colour?

- a) Three floors below
- b) Two floors above
- c) Two floors below
- d) Four floors below
- e) Immediately above

38. How many persons live between the one who likes white and F?

- a) One
- b) Two
- c) Three
- d) Four
- e) No one

39. What is the difference between the floor number of H and the one who likes red colour?

- a) 3
- b) 4
- c) 2
- d) 1
- e) 0

40. If J is related to the one who likes Green and I is related to the one who likes pink in a certain way, then in the same way who among the following person is related to the one who likes violet?

- a) The one who lives two floors below G
- b) I
- c) F
- d) The one who lives on fourth floor
- e) K

Directions (41-45): Study the following information and answer the given question:



Eight persons - A, B, C, D, E, F, G and H are sitting around a circular table facing the centre.

Only two persons sit between A and D (either from left or right). F sits to the immediate left of D. B faces the one who sits second to the left of F. As many persons sit between A and F as between B and C. H faces one of the immediate neighbours of C. G sits two places away from H but not sitting second to the left of E.

41. If all the persons are made to sit in alphabetical order starting from A in a clockwise direction, then who among the following persons remains in the same position?

- i. C ii. H iii. F
- a) Only i
b) Only ii
c) Only iii
d) Both i and ii
e) Both ii and iii

42. Four of the following five are alike in a certain way based on the given arrangement and thus form a group. Which one of the following does not belong to the group?

- a) EG
b) BA
c) GD
d) CF
e) EH

43. How many persons sit between A and G when counted from the left of A?

- a) One
b) Two
c) Three
d) Four
e) None

44. What is the position of C with respect to B?

- a) Immediate right
b) Immediate left
c) Second to the right
d) Second to the left
e) Fourth to the right

45. Who among the following person sits opposite to B?

- a) F
b) The one who sits immediate right of G
c) E
d) The one who sits second to the left of D
e) C

Directions (46-50): Study the following information and answer the given question:

Nine persons- L, M, N, O, P, Q, R, S and T are sitting around a triangular table in such a way that two of them sit on each side of the table and three of them sit at the corners of the table. All of them are facing the centre.

M sits second to the right of P, either of them sits at the corner of the table. Two persons sit between M and L, who is not an immediate neighbour of P. Q sits to the immediate right of L. As many persons sit between P and Q as between L and S. R and O are immediate neighbours. T sits two places away from R, who does not sit at the corner of the table.

46. Which of the following pair of persons are sitting on the same side of the table?

- i. OR ii. NO iii. PT
- a) Only i
b) Only ii
c) Only iii
d) Both i and ii
e) Both i and iii

47. Who among the following person sits at the corner of the table?

- a) The one who sits to the immediate right of Q
b) O
c) M
d) The one who sits second to the right of N
e) T

48. Which of the following statement is true as per the given arrangement?

- a) O sits at the corner of the table
b) N and M are sitting on the same side of the table
c) P and Q are immediate neighbours
d) S sits at the corner of the table
e) None of the above

49. Four of the following five are alike in a certain way based on the given arrangement and thus form a group. Which one of the following does not belong to the group?

- a) L
- b) O
- c) R
- d) N
- e) Q

50. If all the persons are made to sit in alphabetical order starting from L in an anti-clockwise direction, then the position of how many persons remain unchanged (excluding L)?

- a) One
- b) Two
- c) Three
- d) Four
- e) None

Directions (51-55): Study the following information and answer the given question:

Eight persons - L, M, N, O, P, Q, R, and S were born in different years -1983, 1987, 1989, 1992, 1995, 1997, 2001, and 2005. The ages of the persons are calculated with respect to the year 2023.

P is six years elder than M. As many persons elder than M as younger than S. The difference between the ages of S and R is 10 years. Only one person was born between R and O, where O is not elder than R. The sum of the ages of P and Q is 62 years. L is younger than N but was not the youngest person.

51. How many persons are younger than N?

- a) Two
- b) As many persons elder than O
- c) Five
- d) As many persons born between L and O
- e) Four

52. Who among the following person was born in the year 1995?

- a) R
- b) Q
- c) P
- d) L

e) N

53. Who among the following person's age is an odd number?

- a) L
- b) S
- c) Q
- d) M
- e) R

54. As many persons born before Q as after ___?

- a) S
- b) L
- c) P
- d) R
- e) M

55. What is the sum of the ages of R and M?

- a) 70 years
- b) 65 years
- c) 50 years
- d) 48 years
- e) 62 years

Directions (56-60): Study the following information carefully and answer the given questions.

Eight persons - P, Q, R, S, T, U, V and W travelled to Mumbai in three different types of vehicles viz., Bus, Train and Flight. At least two persons but not more than three persons travelled by the same type of vehicle.

Neither R nor T travelled by Bus. Both R and U travelled by the same type of vehicle. T doesn't travel by the same type of vehicle as U. S neither travelled by flight nor travelled by the same type of vehicle as U. Only one person travelled by the same type of vehicle as S. Both Q and V travelled by the same type of vehicle. P doesn't travel by the same type of vehicle as U. W doesn't travel by flight.

56. Who among the following person travelled by flight?

- i. Q ii. T iii. V
- a) Only i
- b) Only ii
- c) All i, ii and iii

- d) Both i and ii
- e) Both ii and iii

57. Who among the following person travelled by the same type of vehicle as P?

- a) T
- b) W
- c) U
- d) R
- e) S

58. Four of the following five are alike in a certain way based on the given arrangement and thus form a group. Which one of the following does not belong to the group?

- a) RU
- b) VP
- c) TW
- d) SR
- e) TR

59. Which of the following statement is TRUE as per the given arrangement?

- a) Q travelled by train
- b) Only two persons travelled by bus
- c) R and Q travelled by the same type of vehicle
- d) Only two persons travelled by flight
- e) None of the above

60. Which of the following pair is correctly matched?

- a) W - Bus
- b) S - Flight
- c) T- Train
- d) U - Train
- e) V- Bus

Directions (61-65): Study the following information carefully and answer the given questions.

Six boxes - S, T, U, V, W and X are kept one above another in the stack. Each box contains different stationery items viz., Glue, Stapler, Label, Marker, Folder and Paper.

The box which contains Stapler is kept two boxes above X but neither of the boxes is kept in the topmost nor bottommost position. As many boxes

kept above the box which contains stapler as below U. The box which contains folder is kept two boxes above U. The box which contains Glue is kept immediately above the box which contains Paper. X doesn't contain glue. T is kept two boxes above S. W is kept immediately below the box which contains Marker. V doesn't contain Label.

61. Which of the following box contains Marker?

- a) Box W
- b) Box U
- c) Box T
- d) Box X
- e) Box S

62. Box W contains which of the following stationery item?

- a) Marker
- b) Label
- c) Paper
- d) Glue
- e) Stapler

63. Which of the following box is kept two boxes below box X?

- a) The box which contains Glue
- b) Box S
- c) Box T
- d) The box which contains Paper
- E) Box W

64. How many boxes are kept between Box S and the box which contains Paper?

- a) One
- b) Two
- c) Three
- d) Four
- e) More than four

65. Which of the following combination is true as per the given arrangement?

- a) T-Glue
- b) U-Paper
- c) X-Label
- d) S-Marker
- e) W-Folder



Directions (66-70): Study the following information carefully and answer the questions below:

Eight people - P, Q, R, S, T, U, V and W joined the school on two different dates either 2nd or 9th of four different months viz., August, September, October and November of the same year.

S joined the school three people before W, who joined in the month which has an odd number of days. Only one person joined between S and U. R joined on an even numbered date but after W. The number of people joined between R and P is two more than the number of people joined before S. Q joined two people after P. Q and V joined the school on different dates. T doesn't join in the adjacent month of V.

66. The number of people joining the school before S is one less than the number of people joining the school after ____.

- a) W
- b) T
- c) R
- d) U
- e) None of these

67. Four of the following five are alike in a certain way based on the given arrangement and thus form a group. Which one of the following does not belong to the group?

- a) V
- b) S
- c) U
- d) R
- e) T

68. Which of the following information is not TRUE as per the given arrangement?

- a) Q joined on an odd numbered date
- b) More than two people joined between S and T
- c) U joined in the month which has an even number of days
- d) P joined three people before U
- e) None of these

69. T joined the school in which of the following month and date?

- a) August- 9
- b) October -2
- c) November-9
- d) September-2
- e) None of these

70. Who among the following person joined the school four people after V?

- a) T
- b) U
- c) W
- d) R
- e) Q

Directions (71-75): Study the following information carefully and answer the questions below:

Eight persons - K, L, M, N, O, P, Q, and R are sitting around a square table in such a way that four of them are sitting at the corners and facing away from the centre while four of them are sitting in the middle of the sides and facing the centre.

Two persons sit between R and N, who doesn't sit in the middle of the side. P sits second to the right of N. Q sits second to the right of M and neither of them is an immediate neighbour of N. L sits immediate left of P. K sits second to the left of O.

71. How many persons sit between L and the one who sits opposite to P?

- a) Two
- b) One
- c) Three
- d) Four
- e) Both (a) and (d)

72. Who among the following person sits third to the right of the one who sits fourth to the left of M?

- a) K
- b) Q
- c) R
- d) N
- e) P

73. What is the position of K with respect to R?

- a) Immediate right



- b) Third to the left
- c) Fourth to the right
- d) Fifth to the left
- e) Immediate left

74. Who among the following person is an immediate neighbour of O?

- a) The one who sits opposite to N
- b) L
- c) The one who sits opposite to R
- d) Q
- e) Both (a) and (d)

75. Who among the following person sits third to the right of L?

- a) P
- b) K
- c) O
- d) Q
- e) N

Directions (76-80): Study the following information carefully and answer the given questions:

Seven persons – A, B, C, D, E, F, and G were born in different years such as – 1957, 1964, 1973, 1982, 1986, 1992, and 1995. Calculate their ages based on the year 2022.

The age of F is a square number. A is 9 years younger than F. Only two persons were born between A and B. E was born in a leap year but before B. The difference between the ages of E and C is not more than six years. The difference between the ages C and D is 22 years.

76. Who among the following person is 36 years old?

- a) F
- b) C
- c) G
- d) A
- e) D

77. How many persons are elder than E?

- a) One
- b) Two
- c) Three
- d) Four

- e) More than four

78. What is the age difference between G and F?

- a) 15 years
- b) 17 years
- c) 20 years
- d) 16 years
- e) None of these

79. Who among the following person was born in 1992?

- a) G
- b) The one who was born immediately after C
- c) D
- d) The one who was born immediately before A
- e) B

80. What is the average age of A and E?

- a) 25
- b) 20
- c) 35
- d) 40
- e) 45

Directions (81-85): Study the following information carefully and answer the given questions.

Fourteen persons are sitting in two parallel rows containing seven persons each in such a way that there is an equal distance between adjacent persons. In row 1: J, K, L, M, N, O and P are seated and all of them are facing north. In row 2: A, B, C, D, E, F and G are seated and all of them are facing south. Each person in row 1 faces another person in row 2.

C sits third to the right of the one who is facing O, who sits immediate left of M. Only three persons sit between M and N. N sits immediate right of J, who sits second to the left of P. As many persons sit J and M as between B and F, who is facing J. K sits to the right of L. Only two persons sit between E and D, who is facing neither K nor P. E sits adjacent to neither B nor G.

81. _ faces _ who sits two places away from F.

- a) P-E
- b) C-N



- c) J-E
- d) E-J
- e) P-G

82. Four of the following five are alike in a certain way based on the given arrangement and thus form a group. Which one of the following does not belong to the group?

- a) PF
- b) KC
- c) ND
- d) MA
- e) BM

83. How many persons sit to the left of K?

- a) As many persons sit to the left of C
- b) No one
- c) As many persons sit to the right of C
- d) One
- e) Three

84. Who among the following person sits third to the right of J?

- a) O
- b) K
- c) P
- d) N
- e) L

85. If F and A are interchanged their positions, then who among the following person sits second to the right of B?

- a) A
- b) G
- c) F
- d) D
- e) C

Directions (86-90): Study the following information carefully and answer the given questions.

Six persons – A, B, C, D, E and F are going to different shops one after another and no two persons go to the same shop.

The one who goes to the mobile shop goes three persons before E. Atleast one person goes after E,

who doesn't go to the Parlour. The number of persons going after A is twice the number of persons going before B, who goes two persons before the one who goes to the Parlour. F goes before C but after D, who goes to the cake shop. Only one person goes between the one who goes to the Textiles shop and F, who goes to either Parlour or Gift shop. One of them goes to the toys shop.

86. Who among the following person goes to the shop at last?

- a) The one who goes to the Textiles shop
- b) C
- c) The one who goes to the parlour
- d) F
- e) B

87. How many persons go to the shop between D and A?

- a) Two
- b) Four
- c) One
- d) Three
- e) None

88. Which of the following pair is incorrect?

- a) F - Gifts
- b) E - Textiles
- c) D - Parlour
- d) B - Mobile
- e) None is false

89. The number of persons going to the shop between B and E is one more than the number of persons going to the shop between _ and C.

- a) A
- b) E
- c) F
- d) D
- e) B

90. Which of the following statements is/are not true as per the given arrangement?

- i) Only Two persons go to the shop after A.
 - ii) Only one person goes to the shop between F and D
 - iii) B is the first person to go to the shop.
- a) Only i



- b) Only ii
- c) Only iii
- d) Only ii and iii
- e) Only i and ii

Directions (91-95): Study the following information carefully and answer the given questions.

Nine persons - R, S, T, U, V, W, X, Y and Z are working in the Indian Police at different designations such as Commissioner, Senior Superintendent of police (SSP), Superintendent of police (SP), Inspector of Police (INS), Sub-Inspector of Police (SI), Assistant Sub-Inspector of Police (ASP), Police Head constable (HC), Senior Police Constable (SPC) and Police Constable (PC). The designations are given in decreasing order such as Commissioner is the senior-most designation and PC is the junior-most designation.

Y is designated as INS. Only two persons are designated between Y and X. As many persons junior to X as senior to W. The number of persons designated between W and Y is same as the number of persons designated between X and U. S is senior to Z but junior to U. T is designated as neither SI nor SSP but junior to V.

91. Who among the following person is designated as SI?

- a) S
- b) Z
- c) R
- d) T
- e) U

92. How many persons are designated between T and U?

- a) As many persons senior to X
- b) Four
- c) Three
- d) As many persons junior to S
- e) One

93. If S is related to W and Y is related U in a certain way, then in the same way who among the following person is related to T?

- a) V

- b) R
- c) U
- d) Z
- e) X

94. If the designations of T and S are interchanged, then who among the following person is immediately junior to T?

- a) X
- b) Z
- c) U
- d) R
- e) W

95. If all the persons are designated in alphabetical order from the junior most designation, then how many persons remain in the same designation?

- a) One
- b) Two
- c) Three
- d) None
- e) Four

Directions (96-100): Study the following information carefully and answer the given questions.

A certain number of persons are sitting in a linear row facing north. R sits second to the right of E, who sits sixth from one of the extreme ends. J sits fourth to the left of R. Only seven persons sit between J and P. T sits third to the left of P. Only nine persons sit between T and M, who sits immediate left of O. Z sits exactly between O and P. Q, who sits third to the left of M and sits at the end of the row.

96. How many persons are sitting in the row?

- a) 31
- b) 29
- c) 32
- d) 30
- e) 28

97. What is the position of Q with respect to O?

- a) Sixth to the right
- b) Fourth to the right
- c) Fourth to the left
- d) Fifth to the left



e) None of these

98. Who among the following person sits seventh to the right of M?

- a) T
- b) E
- c) Z
- d) Not known
- e) R

99. If A sits fourth to the right of P, then how many persons sit between A and R?

- a) Six

b) Three

c) Seven

d) Eight

e) Five

100. Which of the following statement is TRUE as per the given arrangement?

- a) Only three persons sit between M and Z
- b) Only five persons sit between P and E
- c) T sits third to the left of Z
- d) Only three persons sit to the left of M
- e) None is true

WINNER INSTITUTE
India's Best Banking Institute

**BANKING MAINS
SPECIAL BATCH**

**STARTING
SOON**

Bank | RBI
SSC | CAT
NABARD | SEBI
Railway Insurance

www.winnerinstitutes.com | [winnerinstitute Pune App](#) | [Search on Google](#)

99 22 41 6666 / 80 87 367 666

Indulal Complex, Near Senadatta Police Chowky & Kaka Halwai,
LBS Road, Navi Peth, Pune-411 030.

Answer

Q.1. D	Q.11. C	Q.21. D	Q.31. B	Q.41. D	Q.51. B	Q.61. C	Q.71. E	Q.81. A	Q.91. C
Q.2. B	Q.12. D	Q.22. B	Q.32. E	Q.42. A	Q.52. C	Q.62. E	Q.72. C	Q.82. E	Q.92. D
Q.3. A	Q.13. A	Q.23. E	Q.33. C	Q.43. E	Q.53. A	Q.63. D	Q.73. C	Q.83. A	Q.93. E
Q.4. E	Q.14. E	Q.24. C	Q.34. A	Q.44. C	Q.54. D	Q.64. B	Q.74. E	Q.84. B	Q.94. B
Q.5. C	Q.15. B	Q.25. A	Q.35. D	Q.45. B	Q.55. D	Q.65. C	Q.75. D	Q.85. C	Q.95. A
Q.6. E	Q.16. B	Q.26. A	Q.36. C	Q.46. E	Q.56. C	Q.66. D	Q.76. B	Q.86. B	Q.96. C
Q.7. A	Q.17. C	Q.27. D	Q.37. B	Q.47. C	Q.57. E	Q.67. E	Q.77. E	Q.87. A	Q.97. C
Q.8. D	Q.18. D	Q.28. B	Q.38. E	Q.48. D	Q.58. A	Q.68. C	Q.78. D	Q.88. C	Q.98. C
Q.9. C	Q.19. A	Q.29. E	Q.39. A	Q.49. A	Q.59. B	Q.69. C	Q.79. B	Q.89. A	Q.99. C
Q.10. B	Q.20. E	Q.30. C	Q.40. D	Q.50. B	Q.60. D	Q.70. B	Q.80. C	Q.90. C	Q.100. D

Explanation

(01-05)



(06-10)

Floor	Flat A		Flat B	
3	P	Haryana	O	Kerala
2	Q	Assam	N	Bihar
1	R	Gujarat	M	Punjab

(11-15)

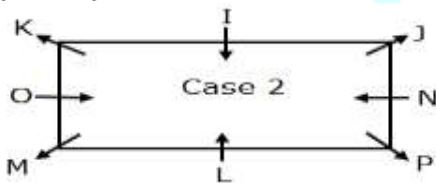

(16-20)

Designations	Persons
Air Chief Marshal	S
Air Commodore	U
Group Captain	Q
Wing Commander	V
Squadron Leader	W
Flight Lieutenant	T
Flying Officer	P
Air Craftsman	R

(21-25)

Months	Persons
January	E
March	L
April	F
June	G
July	K
September	H
October	I
November	D
December	J

(26-30)

Days	Persons
Monday	T
Tuesday	S
Wednesday	V
Thursday	W
Friday	R
Saturday	X
Sunday	U

(31-35)

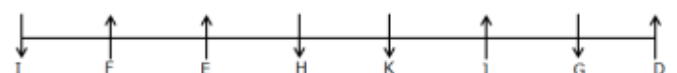

(36-40)

Floors	Persons	Colour
6	I	White
5	F	Pink
4	H	Blue
3	J	Violet
2	K	Green
1	G	Red

(41-45)

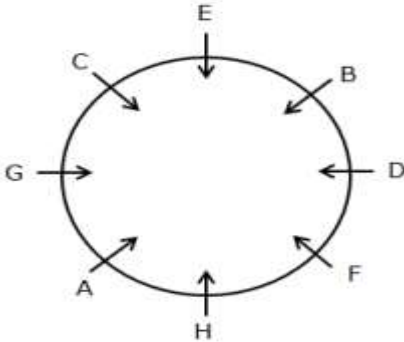

(46-50)

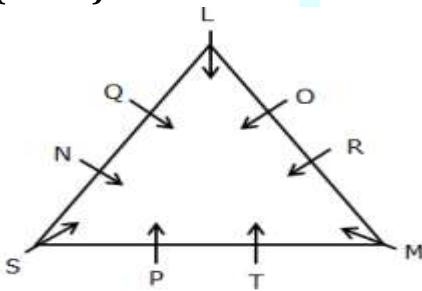

(51-55)

Year	Persons
1983	N
1987	S
1989	Q
1992	L
1995	P
1997	R
2001	M
2005	O

(56-60)

	Bus	Train	Flight
Persons	S, P	R, U, W	T, Q, V

(61-65)

Box	Item
T	Marker
W	Stapler
S	Folder
X	Label
U	Glue
V	Paper

(66-70)

Months	Dates	Persons
August	2	V
	9	P
September	2	S
	9	Q
October	2	U
	9	W
November	2	R
	9	T

(71-75)

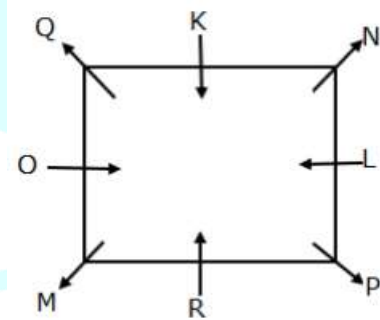

(76-80)

Years (Age)	Persons
1957 (65)	G
1964 (58)	D
1973 (49)	F
1982 (40)	A
1986 (36)	C
1992 (30)	E
1995 (27)	B

(81-85)

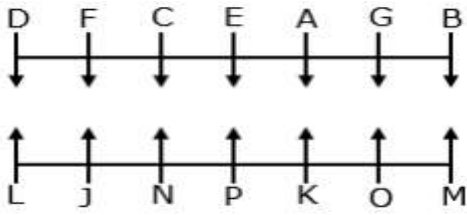

(86-90)

Persons	Shops
D	Cakes
B	Mobile
F	Gifts
A	Parlour
E	Textiles
C	Toys

(91-95)

Designations	Persons
Commissioner	X
SSP	V
SP	T
INS	Y
SI	R
ASP	U
HC	S
SPC	Z
PC	W

(96-100)

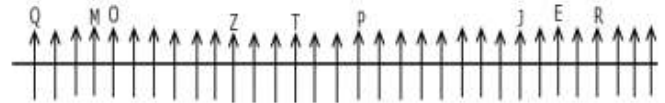



WINNER INSTITUTE

India's Best Banking Institute

SBI / IBPS / RBI / RRB / SSC / CET / CRT / CAT

SBI - IBPS PO / CLERK SPECIAL BATCH

STRATEGIC FEATURES

PRELIMS & MAINS <small>Basic to Advance</small>	150+ PROBLEMS PER CHAPTER SOLVED WITH SHORTCUTS	EX-BANKERS & WELL EXP. FACULTY MEMBERS	DAILY OFFLINE & ONLINE TEACHING
COMPUTER LAB FOR MOCK TEST	DOUBT SOLVING SESSIONS	ONLINE APP 2000+ VIDEOS	FREE TEST SERIES & ANALYSIS
FULLY AIR-CONDITIONED BIG CLASS ROOMS	GDPF PREPARATION UNDER NETD.AGR & EX-CHIEF MANAGERS OF BANKS	3399 SQ.FT PARKING & STUDY ROOM FACILITY	30 BOOKS OF 3000 PAGES STATE OF THE ART UNIQUE STUDY MATERIAL

मासिक १२ प्रसारित २२२८७ उमेदवारांना परास्वीकारिते घालण्यासाठी विभक्त्याली परीक्षा.

Search on Google
www.wiceindia.com
[winnerinstitute app](#)
99 22 41 6666 / 80 87 167 666

Puzzles

Directions (1-5): Study the following information carefully and answer the given questions.

Eight persons – L, M, N, O, P, Q, R and S live on four different floors of a four storey building where the lowermost floor is numbered one and the floor immediately above it is numbered two and so on.

Note-I: Each floor has two flats viz., Flat-A and Flat-B, where Flat A is to the west of Flat B.

Note-II: Flat B of floor 2 is immediately above Flat B of floor 1 and immediately below Flat B of floor 3 and so on. Similarly, Flat A of floor 2 is immediately above Flat A of floor 1 and immediately below Flat A of floor 3 and so on.

Note-III: Area of each flat on each floor is equal.

Note-IV: Only two persons live on each floor and only one person lives in each flat.

R lives on an odd numbered floor. S lives immediately below the flat of R. As many floors above S as below P. Only one floor is between P and N where both live in different type of flats. L lives immediately above N. L and O are not living in the same type of flat. M lives above Q. No one lives to the east of Q.

1. P lives on which of the following floor and flat?

- a) Floor 4, Flat B
- b) Floor 3, Flat B
- c) Floor 2, Flat A
- d) Floor 1, Flat B
- e) Floor 1, Flat A

2. Who among the following person lives on the same floor as L?

- a) The one who lives two floors above O's flat
- b) N
- c) The one who lives immediately above N's flat
- d) P
- e) M

3. If O is related to M and S is related to L in a certain way, then in the same way who among the following person is related to Q?

- a) P
- b) R
- c) L
- d) N
- e) M

4. Who among the following person lives two floors above N?

- a) P
- b) O
- c) M
- d) R
- e) Both P and R

5. Which of the following statement(s) is/are TRUE as per the given arrangement?

I. M lives three floors above N.

II. O lives above L.

III. P lives in Flat B.

- a) Only I
- b) Only II
- c) Only I and III
- d) Only I and II
- e) All I, II and III

Directions (6-10): Study the following information carefully and answer the given questions.

Eight persons - P, Q, R, S, T, U, V and W joined the government job in different months viz., January, March, April, June, July, September, October, and December of the same year.

U joined the job in the month which has an even number of days. P joined three months after U. As many persons joined after P as before S. Only two persons joined between S and T, who joined before July. R did not join in the month having an odd number of days. As many persons joined between T and V as between R and W, who joined after V. Q joined two months after W.



6. How many persons joined between V and W?

- a) As many persons joined before U
- b) One
- c) Three
- d) As many persons joined after S
- e) No one

7. Which of the following statement(s) is/are TRUE as per the given arrangement?

I. R joined before V.

II. W joined two persons after P.

III. S joined in June.

- a) Only I
- b) Only II
- c) Only I and III
- d) Only I and II
- e) Only II and III

8. Who among the following person joined two months after P?

- a) R
- b) W
- c) T
- d) V
- e) S

9. How many months are there between the joining months of R and Q?

- a) Five
- b) Two
- c) Three
- d) Six
- e) Four

10. Four of the following five are alike in a certain way based on the given arrangement and thus form a group. Which one of the following does not belong to the group?

- a) W
- b) P
- c) Q
- d) V
- e) U

Directions (11-15): Study the following information carefully and answer the given questions.

Seven persons - L, M, N, O, P, Q and R have NEET exams on different days of the same week starting from Monday to Sunday. No two persons have the exam on the same day.

O has the exam three days before Q but not on Monday. As many persons have the exam after Q as before R. Both R and L have the exam on consecutive days. Only two persons have the exam between L and P, who has the exam after Wednesday. N has the exam before M. More than two persons have the exam between M and N.

11. Which of the following statements is/are not TRUE as per the given arrangement?

I. No one has the exam before N.

II. R has the exam after M.

III. As many persons have the exam before O as after L.

- a) Only I
- b) Only II
- c) Only I and III
- d) Only I and II
- e) Only II and III

12. How many persons have the NEET exam between O and M?

- a) One
- b) Two
- c) Four
- d) Three
- e) No one

13. As many persons have the exam before N as after ____.

- a) O
- b) The one who has the exam on Sunday
- c) M
- d) The one who has the exam on Wednesday
- e) Q

14. If O is related to L and Q is related to P in a certain way, then in the same way who among the following person is related to R?

- a) N
- b) L
- c) O
- d) P
- e) M



15. Who among the following person has the exam before L?

- a) P
- b) M
- c) Q
- d) No one
- e) O

Directions (16-20): Study the following information carefully and answer the given questions.

Six persons - L, M, N, O, P, and Q are sitting in a linear row facing towards the north direction. They use different brands of laptops viz., Dell, HP, Lenovo, Apple, Acer and Asus.

M sits third to the left of the one who uses Apple, who does not sit at the extreme end. Only one person sits between M and N. As many persons sit to the right of Q as to the left of N, who is an immediate neighbour of the one who uses HP. O sits three places away from the one who uses HP. does not sit at the extreme end. The one who uses Asus sits third to the right of the one who uses Lenovo. O does not use Acer. The one who uses Dell is not an immediate neighbour of the one who uses Asus.

16. How many persons sit between P and the one who uses Apple?

- a) One
- b) Two
- c) As many persons sit between M and O
- d) Four
- e) As many persons sit to the right of O

17. Who among the following person sits at the extreme end of the row?

- a) P
- b) The one who uses Acer
- c) Q
- d) The one who uses Dell
- e) Both (a) and (d)

18. Who among the following person sits second to the right of the one who uses HP laptop?

- a) P

- b) M
- c) Q
- d) L
- e) O

19. What is the position of P with respect to N?

- a) Immediate right
- b) Third to the right
- c) Second to the right
- d) Second to the left
- e) Third to the left

20. Which of the following statements is/are not false as per the given arrangement?

I. M uses Acer laptop.

II. N sits at the end of the row.

III. Q sits third to the left of O.

- a) Only I
- b) Only II
- c) Only I and III
- d) Only I and II
- e) Only II and III

Directions (21-25): Study the following information carefully and answer the given questions.

Nine persons - P, Q, R, S, T, U, V, W and X are watching three types of movies viz., Horror, Comedy, Romantic in the same theater. At least two persons but not more than four persons are watching the same movie.

Note: If it is given that A is watching with B, then both A and B are watching the same movie.

Both P and S are watching the same movie but not a Romantic movie. T is watching with U but both of them are neither watching Horror movie nor watching with P. The number of persons watching comedy movie is one more than the number of persons watching Horror movie. R is watching neither with T nor with S. Both W and X are watching the same movie with R. Both Q and V are neither watching with R nor watching with U.

21. Who among the following person is watching Romantic movie?

- a) Q



- b) T
- c) V
- d) W
- e) None of these

22. If A watches the same movie as W, then who among the following person watches the same movie with A?

- a) P
- b) X
- c) S
- d) R
- e) Both b and d

23. How many persons are watching Comedy movie?

- a) Two`
- b) Three
- c) Cannot be determined
- d) More than three
- e) None of these

24. Which of the following statements is/are TRUE as per the given arrangement?

- a) Both T and U are watching Romantic movie.
- b) Only two persons are watching Horror movie.
- c) Both P and R are watching Comedy movie.
- d) Only four persons are watching Romantic movie
- e) All the statements are true

25. Who among the following persons are watching the movie with P?

- I. Q II. T III. V IV. X
- a) Only I and II
 - b) Only II and IV
 - c) Only I and III
 - d) Both I and IV
 - e) Both II and III

Directions (26-30): Study the following information carefully and answer the given questions.

Eight persons - P, Q, R, S, T, U, V and W attended the seminar in different months viz., July, September, October, December of 2021 and 2022. Only one person attended the seminar in the same month of the same year.

T attended the seminar in the month having an odd number of days but in an even numbered year. Only two persons attended between T and W, who attended before T. U attended two persons before W. The number of persons attended before U is one more than the number of persons attended after V. Only two persons attended between V and P. S and P attended in the same month but in different years. R attended the seminar before Q.

26. S attended the seminar in which of the following month and year?

- a) October 2021
- b) July 2022
- c) December 2022
- d) July 2021
- e) None of the above

27. How many persons attended the seminar between U and P?

- a) As many persons attended before Q
- b) Four
- c) Two
- d) Three
- e) As many persons attended after T

28. If all the persons are attending the seminar in alphabetical order from July 2021, then how many persons are unchanged in their position?

- a) No one
- b) One
- c) Two
- d) Three
- e) More than Three

29. Who among the following person attended the seminar in September 2022?

- a) R
- b) V
- c) U
- d) Q
- e) W

30. Which of the following statement is TRUE as per the given arrangement?

- a) R attended the seminar in an odd numbered year
- b) Only two persons attended the seminar between R and P
- c) P attended the seminar immediately after Q
- d) W attended the seminar in the month having an even number of days
- e) None is true

Directions (31-35): Study the following information carefully and answer the given questions.

A certain number of persons are sitting around a circular table and all are facing the center. More than 19 persons are sitting around the table.

Three persons sit between Q and D, who doesn't sit adjacent to R. R is an immediate neighbor of U and sits third to the right of Q. F sits fourth to the right of U. Two persons sit between F and T, who doesn't sit adjacent to U. Four persons sit between D and T. D sits three places away from K, who is not an immediate neighbour of Q.

31. How many persons sit between K and F, when counted from the right of F?

- a) More than four
- b) None
- c) Two
- d) Four
- e) Three

32. What is the position of U with respect to Q?

- a) Fourth to the right
- b) Fifth to the left
- c) Seventh to the right
- d) Third to the left
- e) Second to the right

33. How many persons are sitting around the Circular table?

- a) 29
- b) 20
- c) 21
- d) 23
- e) 25

34. If X sits two places away from K, then who among the following person is an immediate neighbour of X?

- a) R
- b) Q
- c) T
- d) F
- e) D

35. Who among the following person sits fifth to the left of D?

- a) F
- b) The one who sits third to the right of Q
- c) U
- d) The one who sits second to the left of K
- e) None of these

Directions (36-40): Study the following information carefully and answer the given questions.

Six persons - U, V, W, X, Y and Z are sitting around a rectangular table in such a way that two persons sit on each longer side while one person sits on each smaller side of the table. All of them are facing the centre. They use different brand pens - Sheaffer, Pilot, Aurora, Parker, Waterman, and Montblanc.

W sits immediate left of the one who uses Montblanc but both sit on different sides. Only two persons sit between W and Z. The one who uses Sheaffer sits second to the right of Z. U sits immediate right of X. Neither X nor V use Montblanc. The one who uses Aurora sits immediate left of the one who uses Pilot. V uses neither Aurora nor Parker. V does not sit opposite to the one who uses Parker.

36. Which of the following brand of pen used by V?

- a) Waterman
- b) Montblanc
- c) Pilot
- d) Sheaffer
- e) None of these



37. Which of the following combination is false?

- a) W-Parker
- b) X-Sheaffer
- c) Z-Aurora
- d) V-Waterman
- e) Y-Montblanc

38. How many persons sit between Y and W, when counted from the left of Y?

- a) None
- b) One
- c) Two
- d) Three
- e) Four

39. What is the position of X with respect to the one who uses Waterman?

- a) Third to the right
- b) Second to the left
- c) Immediate right
- d) Second to the right
- e) Immediate left

40. Who among the following person sits opposite to the one who uses Parker?

- a) The one who uses Waterman
- b) U
- c) Y
- d) The one who uses Aurora
- e) X

Direction (41-45): Study the following information carefully and answer the given questions.

Six persons - L, M, N, O, P, and Q are living on different floors of a six-storey building where the bottommost floor is numbered one and the floor immediately above it is numbered two and so on. Each person prepared different types of Briyani - Fish, Prawn, Mutton, Chicken, Mint, and Paneer Tikka.

P lives two floors above the one who prepared Mutton Briyani, where neither of them lives on the topmost floor nor on the bottommost floor. Only two persons live between P and O. N lives immediately above the one who prepared

Chicken Briyani, which is not prepared by P. The one who prepared Paneer Tikka Briyani lives two floors below N. The one who prepared Fish Briyani lives three floors above Q. M lives immediately below the one who prepared Mint Briyani. L doesn't prepare Prawn Briyani.

41. Which of the following briyani was prepared by M?

- a) Mutton briyani
- b) Paneer Tikka briyani
- c) Prawn briyani
- d) Chicken briyani
- e) Fish briyani

42. Which of the following combinations is/are TRUE as per the given arrangement?

- I. L – Chicken briyani
 - II. P – Paneer Tikka briyani
 - III. M – Prawn briyani
 - IV. O – Fish briyani
- a) Only I and IV
 - b) Only I and III
 - c) Only III and IV
 - d) Only II and III
 - e) Only I and II

43. Who among the following person was prepared Fish Briyani?

- a) L
- b) P
- c) The one who lives on the topmost floor
- d) M
- e) The one who lives immediately below M

44. Q lives on which of the following floor?

- a) Third
- b) Sixth
- c) Fifth
- d) Fourth
- e) Second

45. How many persons live below the one who prepared Paneer Tikka?

- a) As many persons live above Q
- b) Two
- c) One
- d) None



e) As many persons live between N and O

Directions (46-50): Study the following information carefully and answer the questions given below.

Eight persons E, H, K, P, R, U, W and Z completed police training in eight different years viz. 2012 to 2019, but not necessarily in the same order.

P completed the training three years after U. Only three persons completed the training between K and U. K doesn't complete on an odd numbered year. The number of persons completed before P is one more than the number of persons completed after H. Only one person completed the training between H and E. The difference between the years in which W and R completed is three years. Both Z and R completed the training in consecutive years.

46. Who among the following person completed the training in 2018?

- a) The one who completed immediately after P
- b) U
- c) The one who completed two years after E
- d) P
- e) Z

47. How many persons completed the training between W and K?

- a) As many persons completed between P and U
- b) Five
- c) As many persons completed between R and E
- d) Three
- e) No one

48. As many persons completed between P and H is same as between Z and ____.

- a) K
- b) E
- c) R
- d) W
- e) None of these

49. Four of the following five are alike in a certain way as per the given arrangement and thus form a group. Who among the following one does not belong to the group?

- a) H
- b) Z
- c) E
- d) R
- e) P

50. If K is related to 2015 and U is related to 2019 in a certain way, then W is related to which of the following year?

- a) 2014
- b) 2012
- c) 2019
- d) 2018
- e) 2017

Direction (51-55): Study the following information carefully and answer the given questions.

Eight persons - A, B, C, D, E, F, G and H are sitting around a circular table in such a way that some of them are facing the centre while some of them are facing away from the centre. Not more than two adjacent persons are facing the same direction.

D sits third to the right of F, who faces the opposite direction to D. One person sits between F and C, who doesn't sit adjacent to D. C sits immediate left of H, who faces the same direction as C. E sits second to the left of H. B faces same the direction as G, who doesn't sit adjacent to A. A doesn't face towards the centre.

51. Four of the following five are alike in a certain way based on the given arrangement and thus form a group. Which one of the following does not belong to the group?

- a) C
- b) F
- c) B
- d) G
- e) E

52. Who among the following person sits second to the left of A?

- a) E
- b) H
- c) C
- d) D



e) F

53. How many persons sit between E and H, when counted from the right of H?

- a) Four
- b) Two
- c) Five
- d) Three
- e) No one

54. G faces the same direction as ____.

- a) D
- b) E
- c) H
- d) C
- e) A

55. Who among the following person sits exactly between F and G?

- a) B
- b) C
- c) D
- d) E
- e) Both (a) and (b)

Direction (56-60): Study the following information carefully and answer the given questions.

Eight boxes viz., P, Q, R, S, T, U, V and W are kept one above another in a stack.

At most two boxes are kept above Box S. Only three boxes are kept between Box S and Box U. Box P is kept two boxes below Box U. Box T is kept immediately above Box P. Only two boxes are kept between Box T and Box W. As many boxes kept above Box W as below Box Q. Box R is kept below Box V.

56. How many boxes are kept between Box Q and the box which is kept immediately below Box S?

- a. None
- b. Three
- c. Two
- d. Four
- e. One

57. What is the position of Box R with respect to Box S?

- a. Two boxes below
- b. Two boxes above
- c. Immediately above
- d. Immediately below
- e. Three boxes below

58. Four of the following five are alike in a certain way based on the given arrangement and thus form a group. Which one of the following does not belong to the group?

- a. S-R
- b. S-Q
- c. Q-U
- d. T-P
- e. V-S

59. Which of the following statements is/are TRUE as per the given arrangement?

- I. Box U is kept two boxes below W.
 - II. Box V is kept below Box P.
 - III. Only one box is kept between Box R and Box Q.
- a. Only I
 - b. Only II and III
 - c. Only I and III
 - d. Only II
 - e. Only III

60. Box W is kept at which of the following position from the bottom of the stack?

- a. 5th
- b. 7th
- c. 2nd
- d. 3rd
- e. 6th

Directions (61-65): Study the following information carefully and answer the given questions.

Eight persons - A, B, C, D, E, F, G, and H resigned from their job in four different months viz, February, May, August and November of two different years viz., 2020 and 2021. Only one person resigned in the same month of the same year.



A resigned from the job in the month having 31 days but in an even numbered year. Only three persons resigned between A and E. F resigned immediately before E. B resigned three months before F. D resigned three persons before B. H resigned in the same month as C, but not resigned before C. G didn't resign after H.

61. H resigned in which of the following month and year?

- a) November 2020
- b) August 2021
- c) February 2021
- d) November 2021
- e) May 2020

62. Who among the following person resigned immediately after B?

- a) H
- b) A
- c) D
- d) G
- e) F

63. Which of the following combination is true as per the given arrangement?

- a) D-November-2020
- b) A-August-2021
- c) E-August-2021
- d) C-November-2021
- e) G-August-2020

64. As many persons resigned from the job before E as after ____

- a) C
- b) D
- c) G
- d) H
- e) B

65. Four of the following five are alike in a certain way based on the given arrangement and thus form a group. Which one of the following does not belong to the group?

- a) DF
- b) AE
- c) BG
- d) EB

e) HC

Directions (66-70): Study the following information carefully and answer the given questions.

Nine persons - A, B, C, D, E, P, Q, R and S are living on different floors of a nine-storey building where the lowermost floor is numbered one and the floor immediately above it is numbered two and so on. No two persons live on the same floor.

E lives on an even numbered floor but below fifth floor. Only three persons live between E and Q. D lives two floors below Q. The number of floors above D is one more than the number of floors below S. R lives four floors above S. Only one floor is between R and A, who doesn't live on the topmost floor. B lives above P but below C. C and A do not live on the adjacent floors.

66. Who among the following person lives on the sixth floor?

- a) The one who lives immediately above C
- b) B
- c) The one who lives two floors below Q
- d) A
- e) S

67. The number of floors between Q and E is one more than the number of floors between D and ____.

- a) S
- b) C
- c) B
- d) Both a and b
- e) Both b and c

68. If P and E are interchanged in their positions, then how many floors are between P and Q?

- a) Two
- b) Three
- c) Four
- d) None
- e) Five

69. B lives on which of the following floor?

- a) Eighth



- b) Sixth
- c) Second
- d) Fourth
- e) Fifth

70. Which of the following pairs of persons are living on the adjacent floors?

- a) QP
- b) RA
- c) PS
- d) QS
- e) BS

Directions (71-75): Study the following information carefully and answer the given questions.

Eight varieties of roses - L, M, N, O, W, X, Y and Z were pasted around a square shaped greeting card in such a way that two roses were pasted on each side of the greeting card.

All the roses were facing away from the centre of the card. L was pasted immediate left of W. Y was pasted third to the right of L. Two roses were pasted between Y and N. Z was pasted adjacent to neither N nor W. O was pasted two places away from Z. M was pasted second to the left of X, which was not pasted on the same side of Rose N.

71. Which of the following rose was pasted third to the right of N?

- a) The rose which was pasted immediate left of Z
- b) M
- c) L
- d) X
- e) The rose which was pasted immediate right of L

72. How many roses are pasted between Z and O, when counted from the left of O?

- a) Two
- b) Three
- c) Four
- d) Five
- e) One

73. If the position of roses M and W are interchanged, then what is the position of X with respect to M?

- a) Second to the right
- b) Immediate left
- c) Second to the left
- d) Third to the left
- e) Immediate right

74. Which of the following statement is TRUE as per the given arrangement?

- a) Two roses were pasted between M and Y, when counted from the right of M
- b) O and W were pasted adjacent to each other
- c) O was pasted second to the right of X
- d) Z was pasted exactly opposite to Y
- e) None is true

75. In which of the following pairs of roses, the first rose was pasted immediate right of the second rose as per the given arrangement?

- I. XN II. ZY III. LW

- a) Only I and II
- b) Only I
- c) Only II and III
- d) Only III
- e) All I, II and III

Directions (76-80): Study the following information carefully and answer the given questions.

Nine nails - P, Q, R, S, T, U, V, W and X are placed around a triangular shaped wall in such a way that one nail is placed on each corner of the wall while two nails are placed in the middle of each side of the wall and all the nails are facing the centre of the wall.

Q is placed at the corner of the wall. Two nails are placed between Q and T. W is placed immediate left of T. S is placed third to the right of W. U is placed adjacent to neither S nor W. P is placed second to the right of U but does not place at the corner. R is placed third to the left of P. One nail is placed between R and V.



76. Which of the following pairs of nails are placed adjacent to S?

- a) XT
- b) RT
- c) QW
- d) QX
- e) QR

77. Which of the following pairs of nails are placed third to the right and third to the left of R respectively?

- a) WV
- b) PX
- c) PQ
- d) TS
- e) WE

78. How many nails are placed between X and Q, when counted from the right of X?

- a) Three
- b) Two
- c) One
- d) Four
- e) None

79. If all the nails are placed in alphabetical order from P in an anti-clockwise direction, then which of the following nails remains unchanged in its position?

I. R II. X III. Q

- a) Only I and III
- b) Only II
- c) Only I and II
- d) All I, II and III
- e) None of these

80. Which of the following pairs of nails are placed on the sides of the wall?

- a) RU
- b) ST
- c) VW
- d) WT
- e) PV

Directions (81-85): Study the following information carefully and answer the given questions.

Eight persons - E, F, G, H, I, J, K, and L paid their first installment in different months- January, March, April, June, July, September, October, and December of the same year. No two persons paid their installment in the same month.

L paid the installment two persons after H, who paid in the month having an even number of days. E paid three persons before G, who paid after September. F paid two months before K. The number of persons paid between K and E is one more than the number of persons paid between G and I. J paid the installment after I.

81. Who among the following person paid the installment in October?

- a) The one who paid immediately after E
- b) F
- c) I
- d) K
- e) The one who paid immediately before J

82. Who among the following person paid the installment in the month which has an odd number of days?

- I) I II) K III) G IV) E
- a) Only (III) and (IV)
 - b) Only (I)
 - c) Only (II) and (III)
 - d) Only (II)
 - e) All (I), (II) and (III)

83. How many persons paid the installment between H and G?

- a) None
- b) More than three
- c) Three
- d) Two
- e) One

84. If all the persons paid their installments in alphabetical order from January, then how many persons remain unchanged in their position?

- a) Two
- b) One
- c) None
- d) Three
- e) More than three



85. I paid the installment in which of the following month?

- a) April
- b) December
- c) July
- d) October
- e) September

Directions (86-90): Study the following information carefully and answer the given questions.

Ten persons - L, M, N, O, P, Q, R, S, T, and U are sitting around a pentagonal-shaped table in such a way that five of them sit at the corners and the remaining five sit in the middle of the side of the table. All of them are facing towards the centre of the table.

O sits third to the right of P, who sits at the corner of the table. N sits second to the right of L, who sits adjacent to neither P nor O. L does not sit at the corner of the table. One person sits between N and M. U sits third to the left of T, who sits at the corner of the table. Q sits two places away from T and is not an immediate neighbour of U. Three persons sit between Q and R.

86. How many persons sit between L and P, when counted from the right of P?

- a) Five
- b) One
- c) Four
- d) Three
- e) Two

87. Four of the following five are alike in a certain way based on the given arrangement and thus form a group. Which one of the following does not belong to the group?

- a) PR
- b) UO
- c) TQ
- d) NM
- e) SR

88. Which of the following statement(s) is/are TRUE as per the given arrangement?

- a) Only four persons sit between U and Q

- b) S sits immediate right of M
- c) No one sits between O and Q
- d) All the statements are false
- e) All the statements are true

89. Who among the following person sits second to the right of S?

- a) The one who sits immediate right of T
- b) N
- c) O
- d) The one who sits immediate left of U
- e) M

90. What is the position of N with respect to Q?

- a) Third to the right
- b) Second to the left
- c) Second to the right
- d) Immediate right
- e) Immediate left

Directions (91-95): Study the following information carefully and answer the given questions.

Eight pots - A, B, C, D, E, F, G and H are kept around a square table in such a way that Four pots are kept at the corners while four pots are kept in the middle of the sides. Also, each pot has a different flower- Lotus, Orchid, Daisy, Lilly, Rose, Iris, Tulips and Peony.

Two pots are kept between C and H, which is kept in the middle of the table. The pot which has Daisy is kept immediate right of H. G has lotus and is kept third to the right of the pot which has Daisy. The pot which has Iris is kept opposite to G. D is kept immediate left of the pot which has Iris. One pot is kept between D and the pot which has Rose. B is kept adjacent to the pot which has Rose. Only three pots are kept between B and F, which does not have orchid. A has Lilly and faces the pot which has Peony.

91. The pot which has Tulips is kept immediate right of ____.

- a) A
- b) The pot which has Daisy
- c) F
- d) C



e) The pot which has Orchid

92. What is the position of D with respect to the pot which has Orchid?

- a) Immediate right
- b) Second to the right
- c) Third to the left
- d) Immediate left
- e) Fourth to the right

93. Which of the following combination is not true?

- a) C-Rose
- b) E-Daisy
- c) B-Tulips
- d) D-Peony
- e) H-Iris

94. ____ is kept second to the left of the pot which has Lotus.

- a) The pot which has Tulips
- b) E
- c) The pot which has Orchid
- d) D
- e) A

95. How many pots are kept between C and D, when counted from the left of D?

- a) Three
- b) One
- c) Two
- d) Four
- e) None

Directions (96-100): Study the following information carefully and answer the given questions

Eight persons - A, B, C, D, E, F, G, and H are sitting in the linear row where four of them face north and four of them face south directions. Not more than two persons sit together are facing the same direction.

G sits third to the right of A and both are facing the same direction. Only one person sits between A and C, who sits at the extreme end. As many

persons sit to the left of E as to the right of B, who is not an immediate neighbour of A. B sits second to the left of F and both are facing the same direction. F is not an immediate neighbour of D, who faces the same direction as B. C and D are facing the opposite direction. H does not face the south direction.

96. Who among the following person sits second to the right of H?

- a) D
- b) A
- c) E
- d) G
- e) C

97. How many persons sit between F and D?

- a) As many persons sit to the right of E
- b) None
- c) Four
- d) Three
- e) As many persons sit between A and G

98. Who among the following person faces the north direction?

- a) F
- b) B
- c) E
- d) G
- e) D

99. If C and A are interchanged their position, then how many persons sit to the left of A?

- a) Four
- b) Three
- c) Two
- d) One
- e) None

100. Which of the following statement is TRUE as per the given arrangement?

- a) D sits immediate right of B
- b) Only one person sits between C and F
- c) G and B are facing the same direction
- d) E and A are facing the opposite direction
- e) None of the statements are true



Answer

Q.1. B	Q.11. E	Q.21. B	Q.31. D	Q.41. A	Q.51. A	Q.61. D	Q.71. E	Q.81. E	Q.91. B
Q.2. C	Q.12. D	Q.22. E	Q.32. A	Q.42. E	Q.52. D	Q.62. E	Q.72. D	Q.82. C	Q.92. A
Q.3. D	Q.13. B	Q.23. D	Q.33. B	Q.43. C	Q.53. C	Q.63. C	Q.73. C	Q.83. C	Q.93. C
Q.4. E	Q.14. A	Q.24. A	Q.34. E	Q.44. A	Q.54. B	Q.64. B	Q.74. B	Q.84. C	Q.94. A
Q.5. E	Q.15. E	Q.25. C	Q.35. D	Q.45. A	Q.55. E	Q.65. D	Q.75. A	Q.85. E	Q.95. B
Q.6. D	Q.16. C	Q.26. D	Q.36. A	Q.46. E	Q.56. E	Q.66. C	Q.76. D	Q.86. C	Q.96. D
Q.7. E	Q.17. E	Q.27. C	Q.37. B	Q.47. C	Q.57. D	Q.67. D	Q.77. B	Q.87. E	Q.97. E
Q.8. A	Q.18. D	Q.28. B	Q.38. A	Q.48. A	Q.58. B	Q.68. B	Q.78. C	Q.88. A	Q.98. D
Q.9. B	Q.19. E	Q.29. D	Q.39. D	Q.49. B	Q.59. C	Q.69. C	Q.79. E	Q.89. D	Q.99. E
Q.10. E	Q.20. C	Q.30. A	Q.40. D	Q.50. E	Q.60. A	Q.70. E	Q.80. A	Q.90. D	Q.100. D

Explanation

(01-05)

Floor	Flat A	Flat B
4	O	M
3	R	P
2	S	L
1	N	Q

(06-10)

Month	Persons
January	T
March	V
April	U
June	S
July	P
September	R
October	W
December	Q

(11-15)

Days	Persons
Monday	N
Tuesday	O
Wednesday	R
Thursday	L
Friday	Q
Saturday	M
Sunday	P

(16-20)

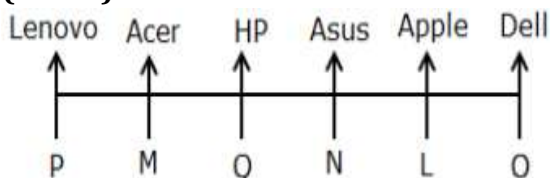

(21-25)

Movies	Horror	Comedy	Romantic
Persons	R, W, X	Q, P, S, V	T, U

(26-30)

Months and years	Persons
July 2021	S
September 2021	U
October 2021	R
December 2021	W
July 2022	P
September 2022	Q
October 2022	T
December 2022	V

(31-35)

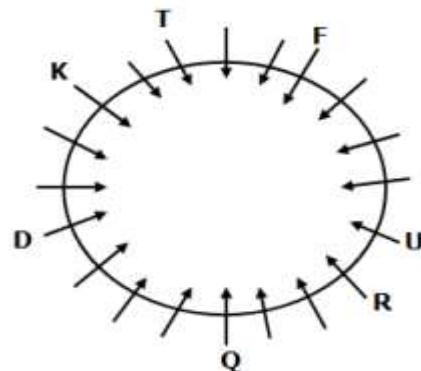

(36-40)

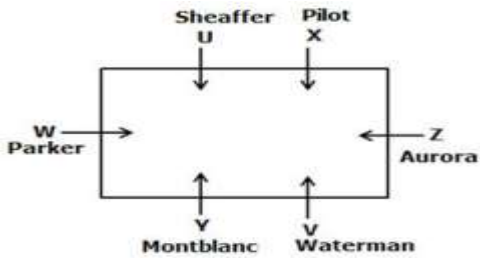

(41-45)

Floor	Person	Briyani
6	N	Fish
5	L	Chicken
4	P	Paneer Tikka
3	Q	Mint
2	M	Mutton
1	O	Prawn

(46-50)

Year	Persons
2012	K
2013	H
2014	W
2015	E
2016	U
2017	R
2018	Z
2019	P

(51-55)

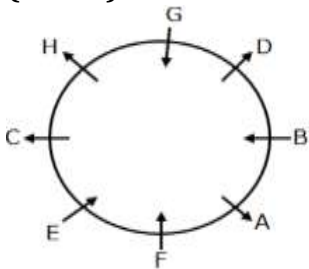

(56-60)

Boxes
V
S
R
W
Q
U
T
P

(61-65)

Year	Month	Persons
2020	February	G
	May	D
	August	A
	November	C
2021	February	B
	May	F
	August	E
	November	H

(66-70)

Floors	Persons
9	C
8	Q
7	R
6	D
5	A
4	E
3	S
2	B
1	P

(71-75)

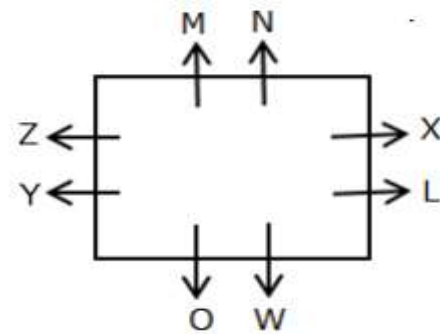

(76-80)

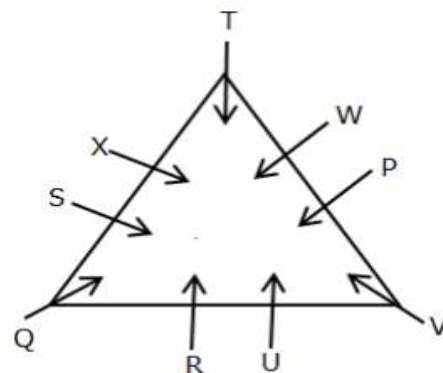

(81-85)

Month	Persons
January	F
March	K
April	H
June	E
July	L
September	I
October	G
December	J

(86-90)

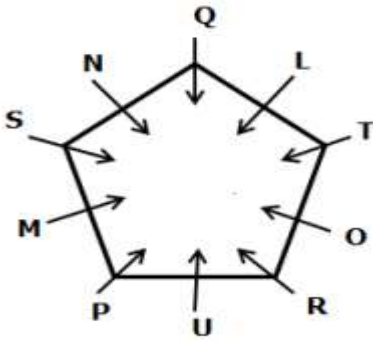

(91-95)

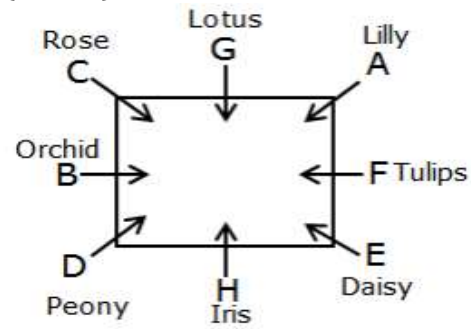

(96-100)

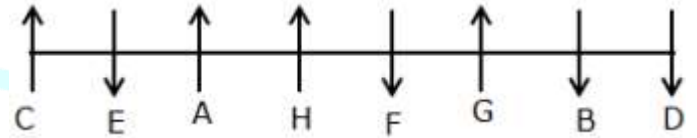

**India's Best Institutes
for the Preparation of**

SBI **IBPS** **RBI**
SSC **LIC** **RRB NTPC**
Staff Selection Commission

Puzzles

Directions (1-5): Study the following information carefully and answer the given questions.

Nine persons – A, B, C, D, E, F, G, H and I are working in the Indian airforce at different designations such as Air chief marshal, Air marshal, Air vice marshal, Air commodore, Group captain, Wing commander, Squadron leader, Flight lieutenant and Flying officer. The designations are given in decreasing order such as Air chief marshal is the senior most designation and Flying officer is the junior most designation.

Only two persons are designated between G and D, who is junior to Wing commander. A is two persons senior to G. Only three persons are designated between A and the one who is immediately junior to I. As many persons senior to I as junior to F. Only one person is designated between F and B, who is not the senior most designated person. E is junior to H but senior to C, who is senior to D.

1. Who among the following person is designated as a Flight lieutenant?

- a) G
- b) D
- c) A
- d) C
- e) I

2. If all the persons are designated in alphabetical order starting from Air chief marshal to Flying officer, then how many persons remain in the same designation?

- a) One
- b) Two
- c) Three
- d) More than three
- e) No one

3. Which of the following statement(s) is/are NOT TRUE as per the given arrangement?

- a) I is immediately senior to C

b) Only five persons are designated between D and F

c) E is an Air vice marshal

d) H is the senior most designated person

e) All are true

4. As many persons senior to A as junior to ____.

- a) F
- b) G
- c) E
- d) C
- e) D

5. What is the designation of I?

- a) Squadron leader
- b) Air marshal
- c) Flying officer
- d) Group captain
- e) Wing commander

Directions (6-10): Study the following information carefully and answer the given questions.

Six persons - U, V, W, X, Y and Z travelled on six different days of the same week starting from Monday to Saturday and each of them belongs to six different cities viz., Madurai, Nellai, Kovai, Dindigul, Salem and Chennai.

Y travelled before Thursday. Only three persons travelled between Y and the one who belongs to Kovai. No one travelled between the one who belongs to Kovai and V. The one who belongs to Nellai travelled immediately before V, who doesn't belong to Kovai. As many persons travelled before the one who belongs to Nellai as after the one who belongs to Dindigul. X travelled two days before the one who belongs to Dindigul. Only three persons travelled between X and the one who belongs to Salem. W travelled three days after U. Only one person travelled between U and the one who belongs to Madurai. Z travelled three days after the one who belongs to Madurai.

6. Who among the following person travelled on Wednesday?



- a) The one who belongs to Nellai
- b) X
- c) The one who belongs to Dindigul
- d) W
- e) V

7. Which of the following statement(s) is/are TRUE as per the given arrangement?

- I) Z belongs to Kovai
 - II) Y travelled two days before the one who belongs to Nellai
 - III) W travelled immediately after V
- a) Only I
 - b) Only I and II
 - c) Only III
 - d) Only II and III
 - e) All are true

8. If all the persons travelled in alphabetical order starting from Monday, then how many persons travelled on the same day?

- a) One
- b) Two
- c) Three
- d) More than three
- e) No one

9. The person who travelled on Friday belongs to which city?

- a) Salem
- b) Kovai
- c) Madurai
- d) Chennai
- e) Nellai

10. As many persons travelled before W as after ___?

- a) V
- b) X
- c) Y
- d) Z
- e) U

Directions (11-15): Study the following information carefully and answer the given questions.

Twelve persons are sitting in two parallel rows containing six persons each in such a way that

there is an equal distance between adjacent persons. In row 1: A, B, C, D, E and F are seated and all of them are facing south. In row 2: L, M, N, O, P and Q are seated and all of them are facing north. Each person in row 1 faces another person in row 2.

Only two persons sit between O and the one who faces F but none of them sits at the extreme ends. L is an immediate neighbour of O and sits second to the left of the one who faces B. As many persons sit to the right of B as to the left of P. Only two persons sit between P and the one who faces D. M sits two places away from L, who faces A. N faces C.

11. Who among the following person sits third to the right of the one who faces D?

- a) N
- b) P
- c) L
- d) M
- e) Q

12. Four of the following five are alike in a certain way based on the given arrangement and thus form a group. Which one of the following does not belong to the group?

- a) L
- b) Q
- c) O
- d) E
- e) C

13. How many persons sit between M and the one who faces B?

- a) One
- b) As many persons sit between E and F
- c) No one
- d) As many persons sit to the left of D
- e) Four

14. Which of the following statement(s) is/are NOT TRUE as per the given arrangement?

- a) M is an immediate neighbour of Q
- b) N sits at the extreme end of the row
- c) F sits third to the right of the one who faces L
- d) A sits immediate left of D
- e) All are true



15. What is the position of C with respect to the one who faces O?

- a) Fourth to the right
- b) Third to the left
- c) Fourth to the left
- d) Immediate right
- e) Second to the left

Directions (16-20): Study the following information carefully and answer the given questions.

Eight persons – P, Q, R, S, T, U, V and W are sitting around a circular table at an equal distance from each other and facing the centre.

Only one person sits between Q and T (either from left or right). W sits third to the right of Q. P sits second to the left of W. Two persons sit between P and U, who doesn't sit opposite to T. R sits two places away from S. R neither faces W nor is an immediate neighbour of V.

16. Who among the following person sits second to the left of the one who sits opposite to V?

- a) The one who sits opposite to U
- b) S
- c) R
- d) The one who sits opposite to Q
- e) W

17. How many persons sit between W and Q?

- a) One
- b) Two
- c) Four
- d) Either one or two
- e) Either two or four

18. If all the persons are made to sit in alphabetical order from P in a clockwise direction, then how many persons will remain unchanged from their initial position (excluding P)?

- a) One
- b) Two
- c) Three
- d) More than three
- e) No one

19. What is the position of S with respect to U?

- a) Fifth to the left
- b) Second to the right
- c) Either (a) or (d)
- d) Third to the right
- e) Immediate right

20. Which of the following statement(s) is/are TRUE as per the given arrangement?

- a) Q sits immediate right of S
- b) P is an immediate neighbour of T
- c) W sits opposite to R
- d) T sits second to the left of Q
- e) More than one is true

Directions (21-25): Study the following information carefully and answer the given questions.

Eight persons D, F, H, J, M, Q, T and W joined in a PSB bank in different years viz. 1982, 1986, 1987, 1992, 1994, 1997, 1998 and 2006. The experience of each person is calculated from the base year 2022. Only one person joined between J and F, whose experience is an odd number. Q joined immediately before J. The sum of the experience of W and H is four years more than the experience of M. The number of persons joined between Q and M is one more than the number of persons joined between D and H. T doesn't join immediately before Q.

21. Who among the following person joined immediately before the one who has 30 years of experience?

- a) The one who joined immediately after H
- b) S
- c) The one who joined two persons before D
- d) F
- e) M

22. How many persons joined between T and Q?

- a) As many persons joined before H
- b) As many persons joined after D
- c) One
- d) Three
- e) No one



23. M joined the bank in which of the following year?

- a) 1986
- b) 1982
- c) 2006
- d) 1994
- e) 1987

24. Which of the following statement(s) is/are true with respect to the final arrangement?

I. Only one person joined between D and Q

II. T joined two persons after J

III. H joined immediately before F

- a) Only III
- b) Only II
- c) Only I
- d) Only II and III
- e) All I, II and III

25. If there is an incentive in a bank for persons whose experience is above 35 years, then who among the following person gets an incentive?

- a) H
- b) T
- c) D
- d) M
- e) Both b and d

Directions (26-30): Study the following information carefully and answer the given questions.

A certain number of persons are sitting in a linear row facing north. R sits second to the right of E, who sits sixth from one of the extreme ends. J sits fourth to the left of R. Only seven persons sit between J and P. T sits third to the left of P. Nine persons sit between T and M, who sits immediate left of O. Z sits exactly between O and P. The number of persons sitting between Z and J is one more than the number of persons sitting between T and Q, who sits at the end of the row.

26. How many persons are sitting in the row?

- a) 31
- b) 29
- c) 32
- d) 30

e) 28

27. What is the position of Q with respect to O?

- a) Sixth to the right
- b) Fourth to the right
- c) Fourth to the left
- d) Fifth to the left
- e) None of these

28. Who among the following person sits seventh to the right of M?

- a) The one who sits third to the left of P
- b) E
- c) The one who sits third to the left of T
- d) Not known
- e) R

29. If A sits fourth to the right of P, then how many persons sit between A and R?

- a) As many persons sit between E and P
- b) Three
- c) As many persons sit to the right of J
- d) Eight
- e) Five

30. Which of the following statement(s) is/are true with respect to the final arrangement?

- a) Only three persons sit between M and Q
- b) Only five persons sit between P and E
- c) T sits third to the left of Z
- d) Only three persons sit to the left of M
- e) None of these

Directions (31-35): Study the following information carefully and answer the given questions.

Nine persons A, B, C, D, E, F, G, H and I are going for vacation to three different places Italy, Singapore and Nepal but not necessarily in the same order.

At least two persons but not more than four persons are going to the same place for vacation. Both C and E are going to the same place. E and D are going to different places, where D is not going to Italy. B goes only with F. The number of persons going to Nepal is one more than the number of persons going to Singapore. G and I are

going to different places where I doesn't go with C. A neither goes with I nor goes to Italy.

31. How many persons are going for vacation to Singapore?

- a) Two`
- b) Three
- c) One
- d) More than three
- e) None of these

32. Who among the following person goes to Italy?

- a) The one who is going with F
- b) C
- c) The one who is going with G
- d) D
- e) None of these

33. If K goes with D, then who among the following person goes along with K?

- a) I
- b) E
- c) Both (a) and (e)
- d) B
- e) H

34. Four of the following five are alike in a certain way based on the given arrangement and thus form a group. Which one of the following does not belong to the group?

- a) B-F
- b) D-H
- c) C-G
- d) I-B
- e) E-A

35. Which of the following statement is true with respect to the final arrangement?

- a) Both A and B are going to the same place.
- b) Only two persons are going to Singapore.
- c) Both F and G are going to the same place.
- d) Only three persons are going to Italy
- e) Both D and F are going to different places.

Directions (36-40): Study the following information carefully and answer the given questions.

Six persons - A, B, C, D, E, and F are living on different floors of the three storey building where the lowermost floor is numbered as one and the floor immediately above it is numbered as two and so on. Each of them likes different colors Yellow, Red, Black, Blue, Grey and White but not necessarily in the same order.

Note-I: Each floor has two flats viz., Flat-1 and Flat-2, where Flat 1 is to the west of flat 2.

Note-II: Flat 2 of floor 2 is immediately above Flat 2 of floor 1 and immediately below Flat 2 of floor 3 and so on. Similarly, Flat 1 of floor 2 is immediately above Flat 1 of floor 1 and immediately below Flat 1 of floor 3 and so on.

Note III: Area of each flat is same

Note-IV: Only two persons live on each floor and only one person lives in each flat.

The one who likes red lives to the east of B, who likes Yellow. Only one floor is between the one who likes yellow and C, where both of them live in different type of flats. The number of floors between B and the one who likes blue is same as the number of floors between C and the one who likes black, who doesn't live in flat 2. D likes neither black nor blue but lives immediately below E's flat. F lives below A, who does not live on the same floor as C. The one who likes white and F are not living in the same type of flat.

36. Who among the following person likes white color?

- a) The one who lives to the west of C
- b) A
- c) E
- d) The one who lives immediately below A
- e) B

37. On which of the following floor and flat does F live?

- a) Floor 2, Flat 1
- b) Floor 3, Flat 2
- c) Floor 2, Flat 2
- d) Floor 1, Flat 1
- e) Floor 1, Flat 2

38. Which of the following pair of persons are living on the same floor?

- I. AB
- II. EA
- III. DC
- IV. CE

- a) Only I and IV
- b) Only I and III
- c) Only III and IV
- d) Only II and III
- e) None of these

39. Who among the following person lives two floors above C?

- a) F
- b) D
- c) E
- d) A
- e) None of the above

40. What is the direction of B's flat with respect to D's flat?

- a) North-east
- b) South
- c) South-west
- d) North-west
- e) North

Direction (41-45): Study the following information carefully and answer the given questions.

Ten persons - A, B, C, D, E, F, G, H, I and J are sitting around a rectangular table in such a way that one person sits on each corner, one person sits on each smaller side and two persons sit on each longer side of the table. The persons sitting at the corners are facing away from the centre and the persons sitting at the sides are facing towards the centre.

D sits third to the right of E and doesn't sit on the smaller side. Two persons sit between D and F. H sits third to the left of F and doesn't sit on the smaller side. The number of persons sitting between H and D is one less than the number of persons sitting between E and I, when counted from the left of both H and E. Three persons sit between I and B. C sits opposite to G, who sits to the immediate left of B. A neither sits adjacent to C nor sits at the corner of the table.

41. Which among the following pair of persons sits at the side of the table?

- a) BC
- b) DI
- c) HG
- d) FA
- e) GC

42. As many persons sit between B and F as between J and __.

- a) I
- b) D
- c) G
- d) E
- e) C

43. Who among the following persons sits third to the right of C?

- a) E
- b) The one who sits to the immediate right of D
- c) B
- d) The one who sits second to the right of G
- e) I

44. If one of the neighbours of H is E, then who among the following person is the second neighbour?

- a) B
- b) C
- c) I
- d) A
- e) J

45. Which of the following statement(s) is/are not true as per the given arrangement?

- a) B and C are facing each other
- b) Only five persons sit between E and A, when counted from the right of A
- c) H and I are facing the same direction
- d) All the given statements are false
- e) All the given statements are true

Direction (46-50): Study the following information carefully and answer the given questions.

Seven persons - M, N, O, P, Q, R and S are sitting in a linear row and facing north. Each of them likes



different colours- Pink, Red, Blue, Black, Green, Orange, and Purple.

M sits second to the left of the one who likes Red. Only two persons sit between M and R, who sits immediate left of the one who likes Blue. S sits third to the left of Q, who sits adjacent to the one who likes Blue. Only one person sits between Q and the one who likes Pink. N sits immediate right of O, who sits two places away from the one who likes Black. The one who likes Green sits immediate right of the one who likes Purple, who doesn't sit at extreme end of the row.

46. Who among the following person likes Black colour?

- a) N
- b) The one who second to the right of R
- c) P
- d) S
- e) The one who sits immediate left of O

47. As many persons sit to the left of M as to the right of ____.

- a) S
- b) Q
- c) P
- d) O
- e) N

48. Four persons sit between ____ and ____.

- a) M, S
- b) N, P
- c) M, O
- d) P, M
- e) S, O

49. Which of the following statements is/are TRUE as per the given arrangement?

I. M likes Red.

II. P sits immediate left of Q.

III. No one sits to the right of O

- a) Only I
- b) Only I and III
- c) Only I and II
- d) Only II
- e) Only III

50. Only two persons sit to the left of the one who likes ____ colour.

- a) Blue
- b) Pink
- c) Green
- d) Purple
- e) Black

Direction (51-55): Study the following information carefully and answer the given questions.

Nine persons – A, B, C, D, E, F, G, H and I are living on different floors of a nine-storey building where the lowermost floor is numbered one and the floor immediately above it is numbered two and so on. No two persons live on the same floor.

Note: The Consecutive alphabetically named persons are not living on the adjacent floors.

F lives on an even numbered floor but below the fifth floor. Only two persons live between F and A. D lives two floors above A. The number of floors below D is one more than the number of floors above B. E lives immediately below B. C lives three floors below G. H lives below C. I doesn't live on an even numbered floor.

51. The number of floors between I and C is one less than the number of floors between G and ____.

- a) B
- b) E
- c) H
- d) F
- e) Both a and c

52. If H and B are interchanged in their position, then how many floors are there between H and F?

- a) As many floors between I and E
- b) Four
- c) Two
- d) As many floors above C
- e) None

53. E lives on which of the following floor?

- a) Eighth
- b) Sixth



- c) Seventh
- d) Fourth
- e) Fifth

54. Which of the following pairs of persons are living on the adjacent floors?

- a) GA
- b) CF
- c) FH
- d) DG
- e) BE

55. Who among the following person lives on the sixth floor?

- a) The one who lives immediately above I
- b) G
- c) A
- d) The one who lives two floors above H
- e) D

Direction (56-60): Study the following information carefully and answer the given questions.

Six persons – P, Q, R, S, T and U received their salary on two different dates either on 12th or 21st of three different months viz., April, July and October of the same year.

Each person is in different profession viz. Teacher, Nurse, Clerk, Manager, Sales executive and Lawyer. S received the salary in the month having 31 days. The one who is a Manager received two persons after S. As many persons received before the one who is a Manager as after P. Only one person received between P and the one who is a Clerk. U received immediately after the one who is a Lawyer. T received the salary on the same date as U but not in April. T is neither Manager nor Clerk. As many persons received between T and the one who is a Manager as before the one who is a Nurse. Neither T nor U is a Teacher. Both Q and the one who is a teacher are not received the salary in the same month. Q is not a Manager.

56. Who among the following person received the salary on October 12?

- a) P

- b) Q
- c) U
- d) S
- e) T

57. How many persons received the salary between U and the one who received on April 12?

- a) One
- b) Two
- c) Three
- d) Four
- e) No one

58. Who among the following person received the salary in the same month with Q?

- a) The one who is a Sales executive
- b) U
- c) S
- d) The one who is a Nurse
- e) R

59. S received the salary on which of the following month and date?

- a) July 12
- b) October 21
- c) July 21
- d) April 12
- e) October 12

60. Which of the following statement is false based on the given information?

- a) T is a Sales executive
- b) Only three persons received between Q and the one who is a Nurse
- c) P received immediately before the one who is a Lawyer
- d) The one who is a manager received the salary on October 21
- e) None of the statements is false

Directions (61-65): Study the following information carefully and answer the given questions.

Eight persons - L, M, N, O, P, Q, R and S are sitting around a square table in such a way that four of them are sitting at the corners and facing away



from the centre while four of them are sitting in the middle of the sides and facing the centre.

O sits third to the right of S. Two persons sit between S and R, who sits immediate left of P. The number of persons sitting between Q and N is two less than the number of persons sitting between P and O, when counted from the left of both P and N. Q does not sit opposite to R. L sits immediate right of the one who sits opposite to N. M is not facing the centre.

61. Who among the following person is facing the same direction as N?

- a) L
- b) Q
- c) S
- d) R
- e) P

62. Which of the following statement is TRUE as per the given arrangement?

- a) Q faces away from the centre
- b) L and S are immediate neighbours
- c) Q sits to the immediate right of N
- d) R and P are facing the same direction
- e) P faces towards the centre

63. Who among the following person sits third to the left of the one who sits immediate right of S?

- a) L
- b) O
- c) Q
- d) R
- e) P

64. What is the position of M with respect to R?

- a) Immediate left
- b) Second to the left
- c) Immediate right
- d) Third to the left
- e) Third to the right

65. Four of the following are alike in a certain way based on the given arrangement and thus form a group. Which one of the following does not belong to the group?

- a) L

- b) Q
- c) M
- d) S
- e) P

Directions (66-70): Study the following information carefully and answer the given questions.

Nine persons - P, Q, R, S, T, U, V, W and X finished a bike race one after the other.

Only three persons finished the race between V and T. V finished three persons before P. Only one person finished between P and X. S finished two persons before X. U finished three persons after S. Only four persons finished between U and Q. The number of persons finished before Q is one more than the number of persons finished after R.

66. Who among the following person finished the race at last?

- a) Q
- b) The one who finished immediately after P
- c) U
- d) T
- e) The one who finished two persons after X

67. How many persons finished the race between V and R?

- a) One
- b) Two
- c) Three
- d) Four
- e) Five

68. P finished the race as the ___ person.

- a) 8th
- b) 4th
- c) 5th
- d) 7th
- e) 3rd

69. As many persons finished the race before W as after ___

- a) Q
- b) V
- c) X
- d) S



e) U

70. Four of the following five are alike in a certain way based on the given arrangement and thus form a group. Which one of the following does not belong to the group?

- a) QS
- b) VW
- c) XP
- d) RS
- e) WT

Directions (71-75): Study the following information carefully and answer the given questions.

Six boxes viz., U, V, W, X, Y, and Z are kept one above another on six different shelves, where the bottommost shelf is numbered one and immediately above it is numbered two and so on. Each box has different gifts such as Watch, Pen, Shoes, Shirt, Ring, and Chocolate. Box X is kept on an even numbered shelf. The box which has Chocolate is kept immediately above box X. As many boxes kept above the box which has chocolate as below box Z. Only two boxes are kept between boxes Z and V. Box U, which has Shoes and is kept two boxes above box W. The box which has Ring is kept immediately above the box which has shirt. Box X neither has a Watch nor has a Ring.

71. Which of the following box has Pen?

- a) Z
- b) W
- c) Y
- d) X
- e) None of these

72. Which of the following combination is NOT TRUE as per the given arrangement?

- a) Y - Watch
- b) Z - Shirt
- c) V - Chocolate
- d) X - Pen
- e) W - Shirt

73. Four of the following are alike in a certain way based on the given arrangement and thus

form a group. Which one of the following does not belong to the group?

- a) X, the box which has Shoes
- b) U, the box which has Ring
- c) V, the box which has Watch
- d) Z, the box which has Shirt
- e) X, the box which has Ring

74. How many boxes are kept between V and W?

- a) Three
- b) Two
- c) One
- d) Four
- e) None

75. Which of the following gift box is kept on the 3rd shelf?

- a) Ring box
- b) Shirt box
- c) Shoe box
- d) Pen box
- e) Chocolate box

Directions (76-80): Study the following information carefully and answer the given questions.

Eight persons are sitting in two parallel rows containing four persons each in such a way that there is an equal distance between adjacent persons.

In row 1: A, B, C and D are seated and all of them are facing south.

In row 2: P, Q, R, and S are seated and all of them are facing north.

Each person in row 1 faces another person in row 2. Each person has different brands bikes such as BMW, Yamaha, Honda, Hero, KTM, Bajaj, TVS and Royal Enfield. Only two persons sit between B and the one who faces S. D, who has TVS bike and faces the immediate neighbour of S. P faces neither B nor D. The one who has BMW bike sits second to the left of A. The one who has Bajaj bike sits second to the left of the one who faces C. R sits to the right of Q and has Yamaha bike. The one who has Hero bike sits second to the left of the one who has Yamaha bike. The one who has KTM Bike



faces north direction. The one who has Honda bike sits to the right of the one who has Royal Enfield, which is not had by A.

76. Who among the following person sits second to the left of P?

- a) R
- b) The one who has Bajaj bike
- c) Q
- d) The one who faces C
- e) None of the above

77. Four of the following are alike in a certain way based on the given arrangement and thus form a group. Which one of the following does not belong to the group?

- a) P
- b) B
- c) S
- d) R
- e) A

78. Which of the following statement is TRUE as per the given arrangement?

- a) C sits at the extreme end
- b) Q has Yamaha bike
- c) B has Royal Enfield bike
- d) P and A are facing each other
- e) S and P are immediate neighbours

79. How many persons are sitting between R and the one who faces A?

- a) As many persons sit to the right of B
- b) One
- c) None
- d) Two
- e) As many persons sit between S and P

80. Who among the following person sits adjacent to Q?

- I) The one who faces C
- II) The one who faces B
- III) The one who faces A
- a) Only (I) and (II)
- b) Only (II) and (III)
- c) Only (III)
- d) Only (II)
- e) Only (I) and (III)

Directions (81-85): Study the following information carefully and answer the questions given below.

Ten persons-P, Q, R, S, T, U, V, W, X and Y are working in a private sector bank. They are working in different designations in decreasing order are as – Chairman, Executive Director(ED), General Manager(GM), Deputy General Manager(DGM), Assistant General Manager(AGM), Chief Manager(CM), Senior Manager(SM), Manager, Probationary Officer(PO) and Clerk whereas Chairman is the senior most employee and clerk is the junior most employee.

Only two persons are designated between P and S where S is junior to P. P is junior to the one who works as DGM. As many persons junior to S as senior to W. Only three persons are designated between X and W. T is three persons senior to X. V is immediately senior to Q but junior to the one who works as CM. The number of persons designated between U and Y is the same as the number of persons junior to Y.

81. Who among the following person works as a Chief Manager?

- A. V
- B. The one who is two persons senior to S
- C. P
- D. The one who is immediately junior to W
- E. X

82. Four of the following five are alike in a certain way and thus form a group. Who among the following one does not belong to that group?

- A. UT
- B. YV
- C. SP
- D. XW
- E. WY

83. How many persons are Junior to W?

- A. Six
- B. As many persons designated between Q and R
- C. As many persons designated between X and U



- D. Four
- E. Three

84. On which of the following designation does V work?

- A. Clerk
- B. Senior Manager
- C. Probationary officer
- D. Manager
- E. Assistant General Manager

85. Which of the following statement is false?

- A. S works as Manager
- B. W works junior to R
- C. Only four persons are designated between Q and P
- D. Y works immediately senior to X
- E. More than Eight persons are senior to V

Directions (86-90): Study the following information carefully and answer the question given below:

Eight boxes- A, B, C, D, E, F, G and H are kept on two different stacks viz. Stack X and Stack Y from west to east respectively. Each stack contains four shelves such that the bottommost shelf is numbered as one and the topmost shelf is numbered as four.

Box G is kept immediately above box D in the same type of stack. Both boxes G and D are kept on the prime numbered shelf. Box A is kept to the north of box D. As many shelves below box A as above box B. Both boxes A and B are kept in different stacks. Both boxes B and F are kept on the same shelf. Box H is kept two shelves below box A. Box C is kept below box E which is not kept in stack Y.

86. Which among the following box is kept towards the north of box H?

- A. G
- B. F
- C. D
- D. C
- E. None of these

87. Which among the following box is kept in stack X of the third shelf?

- A. G
- B. The box which is kept west of box E
- C. C
- D. F
- E. The box which is kept northeast of box C

88. Find the odd one out?

- A. A
- B. H
- C. D
- D. E
- E. C

89. How many shelves are there between box C and box F?

- A. Same as between box E and box D
- B. Three
- C. Same as between box G and box H
- D. Two
- E. None of these

90. Which among the following is a false statement?

- I. Box E is kept below box H.
 - II. Box C is kept above box D.
 - III. Box B and box H are kept in the same stack.
- A. Only III
 - B. Both I and II
 - C. All I, II and III
 - D. Only I
 - E. Both II and III

Directions (91-95): Study the following information carefully and answer the questions given below.

Twelve persons - L to W are sitting around a hexagonal table facing towards the centre, but not necessarily in the same order.

Six persons sit on the corners while six of them sit on the middle of the sides of the table. W sits third to the right of U, who sits in the middle of the sides of the table. Three persons sit between U and M. S sits second to the left of M. T sits third to the right of S. As many persons sit between T and M as between T and O. Q sits second to the right of O. R



sits immediate right of V. Both U and R are not immediate neighbours. N sits second to the right of P.

91. Who among the following person sits third to the left of L?

- A. M
- B. The one who sits immediate right of U
- C. V
- D. The one who sits second to the left of Q
- E. R

92. Who among the following pair of persons are immediate neighbours?

- A. LQ
- B. TW
- C. RU
- D. NW
- E. UO

93. How many persons sit between W and R, when counted from the left of W?

- A. Six
- B. Five
- C. Three
- D. Four
- E. Two

94. Who among the following person sits on the corner of the table?

- A. The one who sits immediate left of T
- B. The one who sits second to the left of Q
- C. R
- D. N
- E. U

95. What is the position of L with respect to V?

- A. Immediate left
- B. Third to the right
- C. Third to the left
- D. Second to the right
- E. Second to the left

Directions (96-100): Study the following information carefully and answer the questions given below.

Eight persons - P, Q, R, S, T, U, V and W are sitting around a circular table facing away from the center. Each person likes different fabric types - Cotton, Denim, Rayon, Wool, Nylon, Linen, Silk and Muslin. All the information is not necessarily in the same order.

R, who doesn't like Nylon, sits third to the right of the one who likes Linen. Two persons sit between the one who likes Linen and Denim. W sits to the immediate left of the one who likes denim and opposite to S. Both P and U, who likes cotton, are immediate neighbors. As many persons sit between U and T as between V and U, who is an immediate neighbor of R. T sits opposite to the one who likes Silk, who sits second to the right of V. Only one person sits between the one who likes Cotton and Muslin. Neither Q nor R likes Wool.

96. Who among the following person likes Rayon?

- A. U
- B. The one who sits second to the right of U
- C. Q
- D. V
- E. The one who sits third to the left of Q

97. How many persons sit between U and the one who likes Wool, when counted from the right of U?

- A. Two
- B. Three
- C. Four
- D. Five
- E. None of these

98. What is the position of V with respect to W?

- A. Immediate right
- B. Second to the right
- C. Second to the left
- D. Third to the right
- E. Third to the left

99. Which of the following statement(s) is/are false as per the final arrangement?

- I. P likes Silk.
 - II. T likes Denim.
 - III. W likes Wool.
- A. Only II



- B. Only I and II
- C. Only III
- D. Only I and III
- E. None in true

- A. Rayon
- B. Silk
- C. Wool
- D. Cotton
- E. Muslin

100. If U is related to Nylon and P is related to Denim in a certain way, then S is related to which among the following fabric?

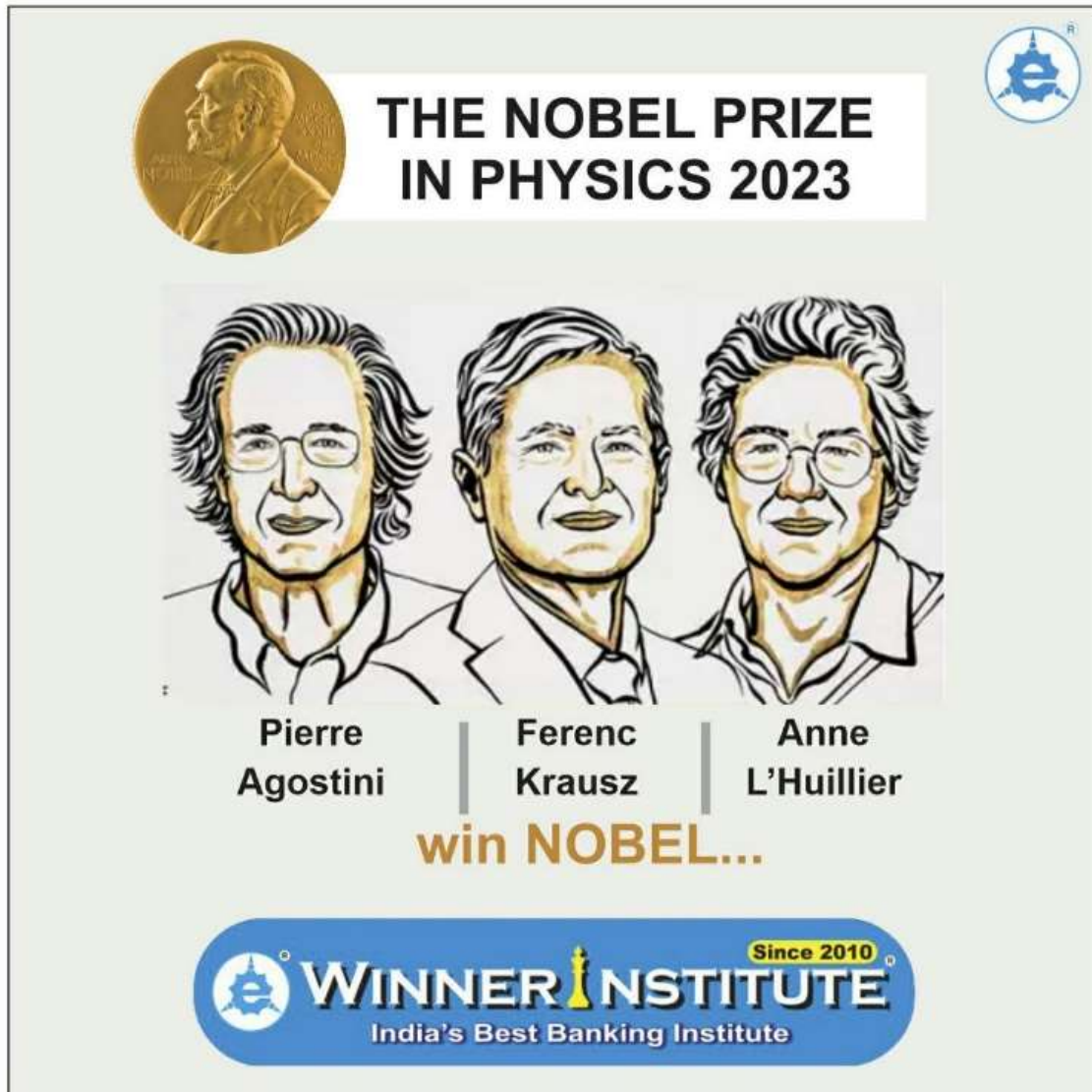

The graphic features a gold Nobel Prize medal in the top left corner. To its right, the text "THE NOBEL PRIZE IN PHYSICS 2023" is displayed in bold black letters. Below this, three stylized portraits of the winners are shown: Pierre Agostini, Ferenc Krausz, and Anne L'Huillier. Their names are printed below each portrait. At the bottom of the graphic, the text "win NOBEL..." is written in a bold, orange font. The logo for Winner Institute, featuring a gear icon, is in the top right corner. At the bottom of the graphic, a blue banner contains the text "WINNER INSTITUTE Since 2010 India's Best Banking Institute".

Answer

Q.1. D	Q.11. B	Q.21. D	Q.31. B	Q.41. D	Q.51. B	Q.61. D	Q.71. D	Q.81. B	Q.91. A
Q.2. E	Q.12. E	Q.22. B	Q.32. A	Q.42. B	Q.52. D	Q.62. E	Q.72. B	Q.82. D	Q.92. A
Q.3. C	Q.13. D	Q.23. A	Q.33. C	Q.43. A	Q.53. C	Q.63. A	Q.73. E	Q.83. B	Q.93. D
Q.4. B	Q.14. C	Q.24. C	Q.34. D	Q.44. E	Q.54. E	Q.64. B	Q.74. A	Q.84. C	Q.94. D
Q.5. A	Q.15. A	Q.25. E	Q.35. E	Q.45. D	Q.55. A	Q.65. C	Q.75. C	Q.85. E	Q.95. E
Q.6. C	Q.16. D	Q.26. C	Q.36. A	Q.46. B	Q.56. E	Q.66. B	Q.76. B	Q.86. D	Q.96. E
Q.7. D	Q.17. E	Q.27. C	Q.37. C	Q.47. C	Q.57. A	Q.67. C	Q.77. A	Q.87. C	Q.97. C
Q.8. E	Q.18. B	Q.28. C	Q.38. B	Q.48. E	Q.58. D	Q.68. A	Q.78. C	Q.88. E	Q.98. D
Q.9. A	Q.19. C	Q.29. C	Q.39. D	Q.49. D	Q.59. C	Q.69. E	Q.79. D	Q.89. A	Q.99. C
Q.10. B	Q.20. E	Q.30. D	Q.40. E	Q.50. A	Q.60. B	Q.70. D	Q.80. E	Q.90. D	Q.100. E

Explanation

(01-05)

Designations	Persons
Air chief marshal	H
Air marshal	E
Air vice marshal	F
Air commodore	A
Group captain	B
Wing commander	G
Squadron leader	I
Flight lieutenant	C
Flying officer	D

(06-10)

Days	Persons	Cities
Monday	X	Madurai
Tuesday	Y	Chennai
Wednesday	U	Dindigul
Thursday	Z	Nellai
Friday	V	Salem
Saturday	W	Kovai

(11-15)

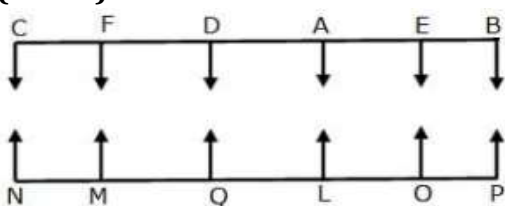

(16-20)

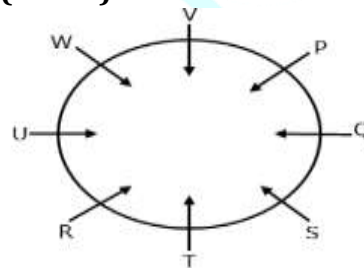

(21-25)

Year	Experience	Person
1982	40	T
1986	36	M
1987	35	F
1992	30	Q
1994	28	J
1997	25	D
1998	24	H
2006	16	W

(26-30)

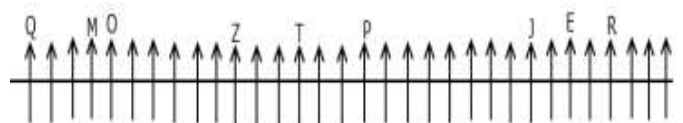

(31-35)

Places	Italy	Singapore	Nepal
Persons	B, F	D, I, H	C, E, A, G

(36-40)

Floors	Flat 1	Flat 2
3	B (Yellow)	A (Red)
2	E (Black)	F (Blue)
1	D (White)	C (Grey)

(41-45)

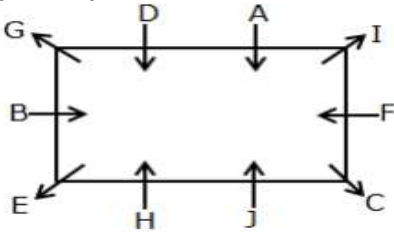

(46-50)

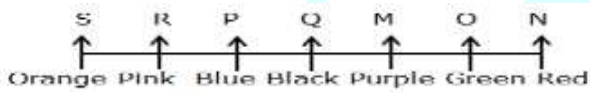

(51-55)

Floors	Persons
9	G
8	B
7	E
6	C
5	I
4	F
3	D
2	H
1	A

(56-60)

Month	Date	Persons	Profession
April	12	P	Nurse
	21	Q	Lawyer
July	12	U	Clerk
	21	S	Teacher
October	12	T	Sales executive
	21	R	Manager

(61-65)

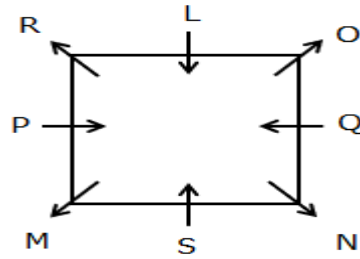

(66-70)

Person
T
Q
W
S
V
X
U
P
R

(71-75)

Shelves	Boxes	Gift item
6	Y	Watch
5	V	Chocolate
4	X	Pen
3	U	Shoes
2	Z	Ring
1	W	Shirt

(76-80)

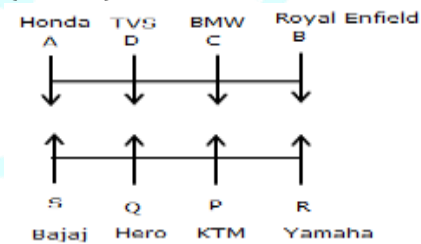

(81-85)

Designations	Persons
Chairman	U
Executive Director	R
General Manager	W
Deputy General Manager	T
Assistant General Manager	P
Chief Manager	Y
Senior Manager	X
Manager	S
Probationary Officer	V
Clerk	Q

(86-90)

Stack Shelve	X	Y
4	E	A
3	C	G
2	H	D
1	B	F

(91-95)

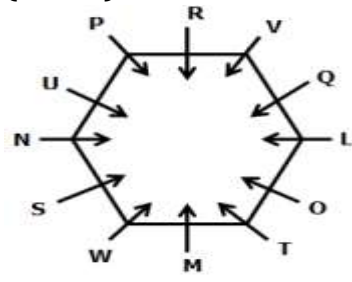

(96-100)

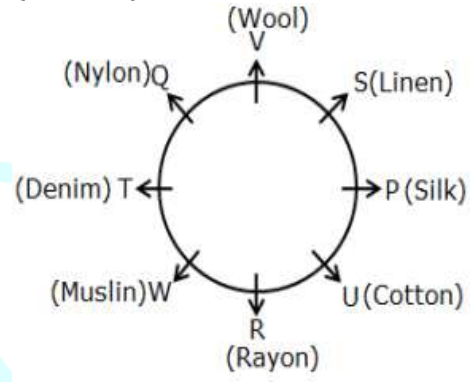

BE THE WINNER ! JOIN OUR TELEGRAM CHANNELS



24x7
Support for
Students

**Students
Doubt
Solving
Group**

For All
Subjects



Puzzles

Directions (1-5): Study the following information carefully and answer the questions given below.

Ten people – J, K, L, M, N, O, P, Q, R, and S are sitting around a pentagonal table in such a way that five people are sitting at the corner of the table while the remaining people are sitting in the middle of the table. All the people are facing the center of the table.

Two people sit between L and Q, who doesn't sit at the corner of the table. Only one person sits between J and L (either from the left or right side). S sits immediate right of J. Five people sit between S and K. R sits third to the left of K. Three people sit between R and O. N sits fifth to the right of O. More than two people sit between N and P, when counted from both sides.

1. Who among the following person sits fourth to the right of Q?

- a) N
- b) The one who sits second to the left of S
- c) J
- d) The one who sits third to the left of K
- e) None of these

2. If all the people are made to sit in alphabetical order from J in an anti-clockwise direction, then who among the following person remains unchanged in their position?

- a) L
- b) M
- c) R
- d) P
- e) Q

3. Which of the following statement(s) is/are TRUE with respect to the final arrangement?

- I) R sits second to the right of S
 - II) L sits five places away from K
 - III) Only four people sit between P and N (when counted from the left of P)
 - IV) Q sits fourth to the left of P
- a) None is true
 - b) Only II and III are true

- c) Only IV is true
- d) Only II, III and IV are true
- e) Only II and IV are true

4. If the positions of K and P are interchanged in the same way the positions R and L are interchanged, then how many persons sit between R and K when counted from the right of R?

- a) Three
- b) Two
- c) Four
- d) More than four
- e) None

5. How many people sit between O and S?

- a) Two
- b) Five
- c) Either a or e
- d) Either a or b
- e) Six

Directions (6-10): Study the following information carefully and answer the questions given below.

A certain number of people are sitting in the linear row facing the north direction. Only three people sit between X and Q. Two people sit between Q and L. S sits immediate right of L. Only five people sit between S and J. M sits two places away from J and sits second from one of the extreme ends of the row. Only four people sit between M and A, who doesn't sit adjacent to Q. Only six people sit between A and P, who sits towards the right of X. As many people sit between P and J as between P and F. E sits eighth to the left of F, who sits at one of the ends of the row.

6. How many persons are sitting in the row?

- a) 23
- b) 22
- c) 24
- d) 19
- e) 25



7. Who among the following persons sits seventh to the right of M?

- a) F
- b) The one who sits immediate right of A
- c) Q
- d) P
- e) The one who sits third to the left of Q

8. If D sits immediate left of Q, then how many persons sit between D and A?

- a) Two
- b) Three
- c) One
- d) Four
- e) Six

9. What is the position of X with respect to E?

- a) Eighth to the left
- b) Seventh to the left
- c) Eighth to the right
- d) Ninth to the left
- e) Sixth to the right

10. As many persons sit between S and P as between ___ and ___

- a) F and E
- b) X and J
- c) E and L
- d) M and A
- e) Q and L

Directions (11-15): Study the following information carefully and answer the questions given below.

Six persons – H, I, J, K, L, and M paid their taxes in six different months – March, May, June, August, September, and October of the same year. They are using six different modes of payment – RTGS, NEFT, UPI, Gpay, Paytm, and Cash, but not necessarily in the same order.

J paid the tax in the month having an even number of days. Only two persons paid the tax between J and the one who uses UPI. L paid the tax two months before the one who uses UPI. As many persons paid the tax before L as after the one who uses Cash. Three months gap between M and the one who uses Cash. No one paid the tax between

M and K, who uses Paytm. K paid the tax three persons after the one who uses Gpay. The one who uses RTGS paid the tax three months after the one who uses Gpay. Only two persons paid the tax between H and the one who uses RTGS. I doesn't use Gpay.

11. Which of the following statement is TRUE with respect to the final arrangement?

- a) L uses RTGS
- b) I paid the tax two persons before K
- c) H paid the tax in March
- d) No one paid the tax between L and J
- e) More than one statement is true

12. How many persons paid the tax between M and the one who uses Cash?

- a) One
- b) As many persons paid the tax before J
- c) Three
- d) As many persons paid the tax after K
- e) None

13. Who among the following persons paid the tax using UPI?

- a) M
- b) L
- c) I
- d) J
- e) H

14. How many months are there between the one who uses RTGS and L?

- a) Six
- b) Two
- c) Five
- d) Three
- e) None

15. J uses which of the following mode of payment?

- a) NEFT
- b) RTGS
- c) Cash
- d) Gpay
- e) UPI



Directions (16-20): Study the following information carefully and answer the questions given below.

Seven satellites – M, N, O, P, Q, R and S were tested on seven different days of the week, starting from Monday to Sunday, but not necessarily in the same order.

Only three satellites were tested between N and R, which doesn't test after Thursday. The number of satellites tested before N is one more than the number of satellites tested after Q. As many satellites tested between Q and M as between M and S. O was tested immediately before S.

16. How many satellites were tested between satellites O and Q?

- a) As many satellites tested after P
- b) One
- c) Three
- d) None
- e) As many satellites tested before R

17. M was tested on which of the following days?

- a) Wednesday
- b) Monday
- c) Thursday
- d) Friday
- e) Saturday

18. Which of the following statement(s) is/are NOT TRUE with respect to the final arrangement?

- I) R was tested two days after P
 - II) O was tested before Friday
 - III) No satellites were tested between M and Q
- a) Only I
 - b) Both I and III
 - c) Only III
 - d) Both II and III
 - e) All are true

19. Which of the following satellite was tested immediately after O?

- a) N
- b) S
- c) R

- d) P
- e) None

20. Four of the following five are alike in a certain way based on the given arrangement and thus form a group. Which one of the following does not belong to the group?

- a) R and the satellite which was tested on Friday
- b) S and the satellite which was tested on Wednesday
- c) Q and the satellite which was tested on Friday
- d) M and the satellite which was tested on Sunday
- e) P and the satellite which was tested on Thursday

Directions (21-25): Study the following information carefully and answer the given questions.

Seven persons - A, B, C, D, E, F and G live on four different floors of a four storey building where the lowermost floor is numbered one and the floor immediately above it is numbered two and so on. One of the flats on any of the floors is left vacant.

Note-I: Each floor has two different types of flats viz., Flat-P and Flat-Q, where Flat P is to the west of flat Q.

Note-II: Flat Q of floor 2 is immediately above Flat Q of floor 1 and immediately below Flat Q of floor 3 and so on. Similarly, Flat P of Floor 2 is immediately above Flat P of floor 1 and immediately below Flat P of floor 3 and so on.

Note-III: Area of each flat on each floor is equal.

Note-IV: If it is given that only one person lives above/below the flat in which A lives, then it means to consider the type of flat (Either P or Q) in which A lives.

G lives on an odd numbered floor and two floors above B, where both live in different type of flats. Only two persons live below the flat in which E lives. Only one floor is between D and E, who lives to the north of B. F lives immediately below the flat of D. G and A neither lives in the same flat nor on the same floor. Only one floor is between A and C, where no one lives to the west of C.

21. Who among the following person lives immediately below the flat of C?

- a) No one
- b) D
- c) A
- d) G
- e) Either a or d

22. Which of the following flat is left vacant?

- a) Flat P of floor 3
- b) Flat Q of floor 2
- c) Flat P of floor 1
- d) Flat Q of floor 4
- e) Flat Q of floor 3

23. Which of the following statements is/are not false as per the given arrangement?

- a) Only one floor is between E and A
- b) B and F live in the same type of flat
- c) No one lives to the south of C.
- d) All the given statement is true
- e) All the given statement is false

24. Which of the following pairs of persons live in the same type of flat?

- a) BD
- b) CE
- c) GD
- d) FA
- e) None of these

25. Who among the following person lives on the same floor with G?

- a) E
- b) No one
- c) F
- d) C
- e) D

Directions (26-30): Study the following information carefully and answer the given questions.

Seven persons – A, B, C, D, E, F and G are sitting in a linear row, which has eight seats and all of them are facing north. One of the seats is vacant.

G sits fifth to the right of B but none of them sits at the extreme end of the row. Only one person

sits between B and C. Only two persons sit between C and D, who doesn't sit adjacent to G. A sits second to the right of D. As many persons sit to the left of A as to the right of E. F doesn't sit at the extreme end of the row.

26. If Y sits at the vacant seat, then what is the position of E with respect to Y?

- a) Fourth to the left
- b) Immediate right
- c) Third to the left
- d) Second to the right
- e) Fourth to the right

27. As many persons sit between G and F as between D and__.

- a) The one who sits at the extreme right end
- b) A
- c) F
- d) C
- e) The one who sits second to the left of C

28. Who among the following person sits adjacent to the vacant seat?

- a) F
- b) G
- c) A
- d) Both a and b
- e) Both b and c

29. How many persons sit to the left of the vacant seat?

- a) Two
- b) Six
- c) Four
- d) Seven
- e) No one

30. In which of the following option, first person sits immediate right of the second person?

- I. AC
- II. FG
- III. AB
- a) Only III
- b) Only I and II
- c) Only II and III
- d) Only I



e) All I, II and III

Directions (31-35): Study the following information carefully and answer the questions given below.

Eight teachers - D, E, F, G, H, I, J and K are teaching different subjects viz., Chemistry, Mathematics and Physics, but not necessarily in the same order. At least two teachers teach each subject.

F and I are teaching different subjects but none of them are teaching Mathematics. D teaches Physics with only one teacher. The number of teachers teaching Chemistry is the same as the number of teachers teaching Mathematics. G and E are teaching the same subject. J and K are teaching different subjects. H doesn't teach the same subject as K. J doesn't teach the same subject as F.

31. H teaches which of the following subject?

- a) Mathematics
- b) Physics
- c) Chemistry
- d) Either a or b
- e) Either b or c

32. Who among the following person teaches the same subject as F?

- a) I
- b) The one who teaches Chemistry
- c) E
- d) The one who teaches Physics
- e) None of these

33. If L teaches Chemistry, then he will teach with which of the following teacher?

- a) D
- b) K
- c) H
- d) E
- e) None of these

34. Which of the following statement(s) is/are true as per the final arrangement?

- I. J teaches Mathematics.
- II. F teaches with only one person.
- III. Both E and F are teaching different subjects.

- a) Both I and II
- b) Only II
- c) Both I and III
- d) Only III
- e) Both II and III

35. Who among the following teachers teaching Physics?

- a) F and D
- b) G and H
- c) D and I
- d) E and K
- e) H and F

Directions (36-40): Study the following information carefully and answer the given questions.

Ten persons are sitting in two parallel rows containing five persons each, in such a way that there is an equal distance between adjacent persons. In row 1: A, B, C, D and E are seated and all of them are facing north. In row 2: V, W, X, Y and Z are seated and all of them are facing south. Each person in row 1 faces another person in row 2.

Only one person sits between Y and Z, but none of them sits at the extreme ends of the row. A sits third to the left of D, who neither faces Y nor Z. The one who sits second to the left of W faces E. C sits to the left of B. The one who faces B sits immediate right of X. V does not sit to the right of Y.

36. Four of the following five are alike in a certain way based on the given arrangement and thus form a group. Which one of the following does not belong to the group?

- a) W
- b) X
- c) A
- d) C
- e) D

37. If all the persons are arranged in alphabetical order within their rows from left to right in both rows, then how many persons remain unchanged in their position?



- a) No one
- b) One
- c) Two
- d) Three
- e) Four

38. Who among the following person sits exactly in the middle of the rows?

- a) V
- b) B
- c) E
- d) Both a and b
- e) Both a and c

39. If C is related to Y and E is related to Z in a certain way, then B is related to who among the following person?

- a) V
- b) D
- c) X
- d) Z
- e) W

40. How many persons sit between W and the person who faces D?

- a) As many persons sit between A and B
- b) No one
- c) Two
- d) Three
- e) As many persons sit to the right of X

Directions (41-45): Study the following information carefully and answer the given questions.

Six persons – A, B, C, D, E and F bought different vegetables viz., Onion, Potato, Cabbage, Brinjal, Carrot and Radish one after another.

Only three persons bought between A and the one who bought carrot. A bought immediately after C, who did not buy Onion. The number of persons bought vegetables before C is one less than the number of persons bought vegetables after the one who bought Brinjal. Only one person bought between the one who bought Brinjal and F. The one who bought Radish bought two persons before D, who neither bought Brinjal nor bought

at last. The one who bought Potato bought immediately before B.

41. Who among the following person bought Onion?

- a) The one who bought immediately before E
- b) E
- c) D
- d) A
- e) The one who bought immediately after A

42. How many persons bought vegetables after B?

- a) None
- b) One
- c) Two
- d) Three
- e) Four

43. Who among the following person bought vegetables at first?

- a) C
- b) F
- c) D
- d) E
- e) A

44. D bought which of the following vegetable?

- a) Carrot
- b) Onion
- c) Radish
- d) Potato
- e) Cabbage

45. Which of the following combination is true?

- a) B-Carrot
- b) F-Brinjal
- c) C-Cabbage
- d) D-Radish
- e) B-Onion

Directions (46-50): Study the following information carefully to answer the questions

Nine books A, B, C, D, E, F, G, H and I are kept in a stack one above another, but not necessarily in the same order.



Only two books are kept between book A and book G. Book G is kept two books above book H. Book E is kept three books above book B which is kept above book H. Only three books are kept between book B and book D, which is neither kept above book H nor kept at the bottom of the stack. As many books kept above book E as below book I. Book F is kept three books above book C.

46. How many books are kept between book F and book I?

- a) Three
- b) Six
- c) Four
- d) Five
- e) None of these

47. Which of the following book is kept immediately below book B?

- a) H
- b) The one which is kept three books above book D
- c) I
- d) The one which is kept immediately above book A
- e) None of these

48. Four of the following five are alike in a certain way as per the given arrangement and hence form a group. Find the one that doesn't belong to that group.

- a) A-B
- b) H-I
- c) G-D
- d) E-F
- e) C-D

49. As many books kept between book F and book H as between book C and book ____.

- a) F
- b) B
- c) C
- d) A
- e) None of these

50. Which of the following statement(s) is/are true with respect to the final arrangement?

- a) Book C is kept immediately above book I

b) Only three books are kept between book A and book H

c) Book G is kept three books above book D

d) All are true

e) None of these

Directions (51-55): Study the following information carefully and answer the questions given below.

Ten persons from different professions viz. Actor, Banker, Chef, Doctor, Editor, Judge, Lawyer, Pilot, Singer and Teacher are sitting around a rectangular table such that all of them are facing towards the centre, but not necessarily in the same order.

Four persons are sitting at the corner, two persons are sitting on each longer side and one person is sitting on each shorter side. Singer sits facing towards Teacher where both of them are sitting on the longer sides of the table. Two persons sit between Singer and Actor, who is not sitting adjacent to Teacher. Banker sits second to the right of Actor and third to the left of Chef. Doctor sits at one of the corners but neither sits adjacent to Chef nor banker. Judge faces the Editor, who does not sit adjacent to Banker. Lawyer sits fourth to the right of Pilot and is not an immediate neighbor of Singer.

51. Who among the following person sits second to the right of Pilot?

- a) The one who sits to the immediate right of Doctor
- b) Teacher
- c) The one who faces Judge
- d) Lawyer
- e) None of these

52. As many persons sit between Actor and ____ as between Lawyer and ____, when counted from the right of Actor and the left of Lawyer.

- a) Singer, Chef
- b) Banker, Judge
- c) Pilot, Doctor
- d) Teacher, Editor
- e) None of these



53. How many persons sit between the Lawyer and the Banker, when counted from the right of Banker?

- a) One
- b) Two
- c) Three
- d) More than three
- e) None

54. If Teacher is related to Chef and Judge is related to Doctor in a certain way, then who among the following person is related to Pilot?

- a) Lawyer
- b) Editor
- c) Singer
- d) Banker
- e) None of these

55. What is the position of Teacher with respect to Doctor?

- a) Second to the left
- b) Third to the right
- c) Second to the right
- d) Third to the left
- e) None of these

Directions (56-60): Study the following information carefully and answer the questions given below.

Six persons viz., P, Q, R, S, T and U were born in seven different years viz., 1974, 1979, 1983, 1992, 1997, 2005, and 2014. Calculate their ages based on the year 2023. There is no person was born in one of the given years.

Only two persons were born between T and Q, whose age is divisible by five. No one was born in one of the even numbered years but before T. Only one person was born between T and S. The sum of the age of S and P is exactly divisible by 15. As many persons born before P as after R.

56. How many persons were born between U and P?

- a) None
- b) As many persons born between S and T
- c) Three

- d) As many persons born before S
- e) Four

57. Who among the following person was born in 1974?

- a) P
- b) L
- c) No one
- d) T
- e) None of these

58. Which of the following statement(s) is/are true with respect to the final arrangement?

- I) U was born immediately after S
 - II) No one was born before P
 - III) R is not the youngest person
- a) Only I is true
 - b) Both I and II are true
 - c) Only III is true
 - d) Both II and III are true
 - e) All are true

59. The sum of the ages of U and T is equal to the age of the who among the following person?

- a) S
- b) Q
- c) R
- d) P
- e) None of these

60. U was born in which of the following year?

- a) 1997
- b) 1979
- c) 2014
- d) 1992
- e) 2005

Directions (61-65): Study the following information carefully and answer the given questions.

Seven persons – A, B, C, D, E, F and G are working in a company with different designations such as Chairman, CEO, MD, GM, Manager, Assistant Manager and Clerk. The designations are given in decreasing order such that Chairman is the senior most designation and Clerk is the junior most designation. Each person takes different number

of days leave in a year - 21 days, 23 days, 25 days, 30 days, 31 days, 32 days and 33 days.

F takes 23 days leave and is senior to GM. The difference between the leaves taken by Manager and CEO is 7 where Manager takes more leaves than CEO. E is the clerk and he takes leave one day more than GM. Only three persons are designated between A and C, where A is senior to C. Only one person is designated between C and D. B is senior to A. Chairman takes less leave than Manager.

61. Who among the following person takes the leave for least number of days?

- a) F
- b) The one who is a CEO
- c) C
- d) The one who is a Chairman
- e) D

62. Which of the following statements is/are true about G?

- a) Only two persons are junior to G
- b) Only two persons are designated between G and A
- c) G is senior to D
- d) Both (a) and (b)
- e) Both (b) and (c)

63. What is the difference between the leaves taken by D and F?

- a) 6
- b) 7
- c) 8
- d) 9
- e) 1

64. Four of the following five are alike in a certain way based on the given arrangement and thus form a group. Which one of the following does not belong to the group?

- a) F
- b) B
- c) G
- d) A
- e) E

65. Which of the following is the correct order according to the leaves taken?

- a) $B < F < A < G < E$
- b) $A < D < E < C < B$
- c) $B < F < D < E < G$
- d) $B < F < G < A < C$
- e) $A < B < G < D < C$

Directions (66-70): Study the following information carefully and answer the given questions.

Seven persons – L, M, N, O, P, Q and R are sitting around a square table such that four seats are at the corners and facing the centre while four seats are in the middle of the sides of the table and facing away from the centre. One of the seats is vacant.

One person sits between L and R, who doesn't sit at the corner of the table. Q sits second to the left of L and doesn't sit adjacent to R. Two persons sit between Q and P. M sits third to the left of P. One person sits between M and O. Both N and O are not immediate neighbours.

66. If Z sits at the vacant seat, then who among the following person sits fourth to the right of Z?

- a) L
- b) Q
- c) O
- d) P
- e) R

67. How many persons sit between R and Q, when counted from the right of R?

- a) Two
- b) Three
- c) One
- d) Four
- e) No one

68. Which of the following pair of persons sit adjacent to the vacant seats?

- a) NO
- b) PQ
- c) MQ
- d) LM
- e) RP



69. Who among the following person sits second to the right of the one who sits opposite to N?

- a) L
- b) Vacant seat
- c) M
- d) Q
- e) R

70. What is the position of Q with respect to M?

- a) Second to the left
- b) Immediate left
- c) Fourth to the left
- d) Third to the right
- e) Second to the right

Direction (71-75): Study the following information carefully and answer the given questions.

A certain number of persons are sitting in the linear row facing north. Only two persons sit between F and T, who sits third from one of the extreme ends. Only five persons sit between F and J. J sits second to the left of L, who sits exactly in the middle of the row. N sits fourth to the left of L. The number of persons sitting to the left of N is one more than the number of persons sitting to the right of V. R sits third to the right of V and sits immediate left of S. S does not sit at the extreme end of the row.

71. How many persons sit in the linear row?

- a) 28
- b) 27
- c) 22
- d) 19
- e) 20

72. Who among the following person sits between L and R?

- a) T
- b) F
- c) N
- d) V
- e) S

73. How many persons sit to the right of S?

- a) One

- b) Two
- c) Four
- d) Three
- e) Five

74. If X sits immediate left of V, then what is the position of L with respect to X?

- a) Fourth to the right
- b) Fourth to the left
- c) Third to the left
- d) Second to the right
- e) Second to the left

75. Which of the following statements is/are TRUE as per the given arrangement?

- I. F and N are immediate neighbours
 - II. Only one person sit between S and T
 - III. Only five persons sit to the left of F
- a) Only I
 - b) Only I and II
 - c) Only II
 - d) Only I and III
 - e) Only III

Directions (76-80): Study the following information carefully and answer the given questions.

Six persons – L, M, N, O, P and Q joined the music class on two different dates either on 6th or 19th of three different months viz. June, August and October of the same year. Each of them likes different musical instruments viz. Violin, Trumpet, Piano, Flute, Drums and Sitar. No two persons joined the class on the same date of the same month.

M joined the music class on an odd numbered date of the month having 31 days. Only two persons joined between M and the one who likes Violin. As many persons joined before the one who likes Violin as after Q. Both Q and the one who likes Flute joined on the same date. Q didn't like Flute. The one who likes Piano joined two months before the one who likes Flute. O joined immediately after the one who likes Piano. O and the one who likes Drums joined on the same date of different months. L didn't join on an even numbered date. Only three persons joined



between L and the one who likes Sitar. P didn't like Drums.

76. Who among the following person joined the music class on June 6?

- a) The one who likes Trumpet
- b) N
- c) P
- d) Q
- e) The one who likes Violin

77. Who among the following person joined the class on an even numbered date?

- I. The one who likes Piano
 - II. The one who joined immediately after N
 - III. The one who likes Trumpet
- a) Only I and III
 - b) Only I and II
 - c) Only III
 - d) Only II
 - e) All I, II and III

78. The one who likes Sitar joined the music class in which of the following month and date?

- a) August 6
- b) October 19
- c) June 19
- d) August 19
- e) June 6

79. Who among the following person joined the class in the same month with M?

- a) O
- b) P
- c) Q
- d) L
- e) N

80. As many persons joined the class before the one who likes drums as after__.

- a) P
- b) The one who likes Sitar
- c) O
- d) The one who likes Piano
- e) M

Directions (81-85): Study the following information carefully and answer the given questions.

Six persons - I, J, K, L, M and N played the game on six different days of the same week from Monday to Saturday. They like different games- Golf, Tennis, Badminton, Cricket, Hockey and Football. I played the game three days after the one who likes Golf but not on Saturday. Only three persons played between the one who likes Golf and M. As many persons played before M as after the one who likes Tennis. K, who likes football and played three days after L. N does not like Golf. M likes neither Hockey nor badminton. The one who likes Hockey played before the one who likes badminton but not immediately before the one who likes badminton.

81. Who among the following person likes Tennis?

- a) J
- b) N
- c) I
- d) L
- e) M

82. How many persons played after K?

- a) Two
- b) Three
- c) One
- d) Four
- e) None

83. If J is related to Wednesday and K is related to Friday in a certain way, then in the same way who among the following person is related to Saturday?

- a) M
- b) I
- c) K
- d) L
- e) J

84. Which of the following sports did J like?

- a) Tennis
- b) Cricket
- c) Golf
- d) Hockey



e) Badminton

85. Which of the following combination is correct?

- a) M - Golf
- b) N - Cricket
- c) J - Tennis
- d) None is correct
- e) I - Badminton

Directions (86-90): Study the following information carefully and answer the given questions.

Nine persons - A, B, C, D, E, F, G, H and I are sitting around a triangular table in such a way that one person sits on each corner while two persons sit on each side of the table. All of them are facing the centre of the table.

One person sits between B and C, who does not sit on the side of the table. I sits third to the right of B. F sits third to the right of C. G sits fourth to the right of the one who sits immediate left of F. D sits second to the left of G. As many persons sit between D and A as between E and B, when counted from the left of both D and E. More than one person sits between H and E, when counted from the left of H.

86. What is the position of F with respect to H?

- a) Third to the right
- b) Immediate left
- c) Second to the right
- d) Fourth to the right
- e) Fifth to the left

87. How many persons sit between A and I, when counted from the left of A?

- a) One
- b) Three
- c) Four
- d) Two
- e) None

88. Who among the following person sits third to the right of E?

- a) F
- b) G

- c) H
- d) C
- e) I

89. _____ sits immediate left of the one who sits fifth to the right of B.

- a) A
- b) G
- c) H
- d) C
- e) D

90. If all the persons are made to sit in the alphabetical order from A in a clockwise direction, then how many persons remain unchanged in their position? (Including A)

- a) One
- b) Two
- c) None
- d) Four
- e) Three

Directions (91-95): Study the following information carefully and answer the given questions.

Seven persons - A, B, C, D, E, F and G are living on different floors of an eight storey building where the lowermost floor is numbered one and the floor immediately above it is numbered two and so on. One of the floors is Vacant. No two persons live on the same floor.

B lives three floors above F and two floors below the vacant floor. The number of persons living below B is one more than the number of persons living above G. More than one person lives between G and A, who lives below the vacant floor. C lives above D and no one lives between them. E and F do not live on the adjacent floors.

91. How many floors are there between G and A?

- a) As many floors above B
- b) Three
- c) As many floors between B and D
- d) None
- e) One



92. Which of the following floor is vacant?

- a) First
- b) Third
- c) Fourth
- d) Sixth
- e) Seventh

93. Which of the following statement is TRUE as per the given arrangement?

- a) G lives above D
- b) B and E live on the adjacent floors
- c) More than one person lives above D
- d) A lives on the topmost floor
- e) E lives above the vacant floor

94. What is the sum of the floor numbers of B and D?

- a) 11
- b) 10
- c) 9
- d) 12
- e) 13

95. As many persons live above G as below ____.

- a) D
- b) C
- c) Vacant floor
- d) B
- e) E

Directions (96-100): Study the following information carefully and answer the given questions.

Eight persons – Q, R, S, T, U, V, W and X are sitting in a linear row in such a way that some of them are facing north while some of them are facing south. The number of persons facing north is more than the number of persons facing south.

S sits second from one of the extreme ends. Only two persons sit between S and R and both face the opposite direction. X sits third to the left of R, where both are not facing the same direction. As many persons sit to the right of X as to the right of V. Only four persons sit between V and W, who sits second to the left of Q. U sits immediate right of Q and both of them are facing the same direction. W faces the

opposite direction of U.

96. How many persons sit towards the right of W?

- a) As many persons sit between T and R
- b) Three
- c) As many persons sit to the right of U
- d) Four
- e) None

97. The number of persons sitting to the left of T is the same as the number of persons sitting to the left of ____.

- a) S
- b) Q
- c) U
- d) V
- e) R

98. Four of the following five are alike in a certain way based on the given arrangement and thus form a group. Which one of the following does not belong to the group?

- a) T
- b) U
- c) V
- d) R
- e) W

99. Which of the following statement(s) is/are TRUE as per the given arrangement?

- I. T and Q face the same direction
 - II. Even number of persons sit between X and S
 - III. S is the only neighbour of V
- a) Only I
 - b) Only II
 - c) Only I and II
 - d) Only I and III
 - e) All I, II and III

100. Who among the following persons sits third to the right of S?

- a) Q
- b) R
- c) U
- d) W
- e) T



Answer

Q.1. B	Q.11. B	Q.21. D	Q.31. C	Q.41. E	Q.51. C	Q.61. D	Q.71. B	Q.81. D	Q.91. C
Q.2. A	Q.12. D	Q.22. E	Q.32. D	Q.42. B	Q.52. A	Q.62. D	Q.72. D	Q.82. A	Q.92. D
Q.3. E	Q.13. C	Q.23. A	Q.33. C	Q.43. A	Q.53. D	Q.63. B	Q.73. C	Q.83. B	Q.93. B
Q.4. D	Q.14. B	Q.24. C	Q.34. E	Q.44. D	Q.54. B	Q.64. C	Q.74. B	Q.84. C	Q.94. A
Q.5. C	Q.15. A	Q.25. B	Q.35. A	Q.45. C	Q.55. A	Q.65. C	Q.75. E	Q.85. E	Q.95. E
Q.6. C	Q.16. E	Q.26. C	Q.36. C	Q.46. D	Q.56. D	Q.66. D	Q.76. E	Q.86. C	Q.96. C
Q.7. E	Q.17. C	Q.27. E	Q.37. B	Q.47. B	Q.57. C	Q.67. A	Q.77. C	Q.87. D	Q.97. A
Q.8. B	Q.18. D	Q.28. B	Q.38. E	Q.48. C	Q.58. B	Q.68. C	Q.78. B	Q.88. C	Q.98. E
Q.9. A	Q.19. B	Q.29. D	Q.39. C	Q.49. D	Q.59. D	Q.69. B	Q.79. A	Q.89. B	Q.99. D
Q.10. B	Q.20. A	Q.30. A	Q.40. D	Q.50. C	Q.60. A	Q.70. E	Q.80. D	Q.90. E	Q.100. B

Explanation

(01-05)

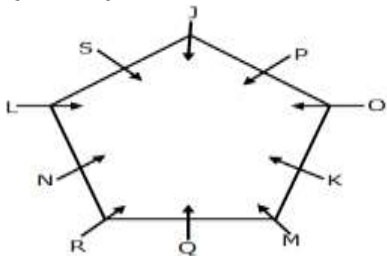

(06-10)

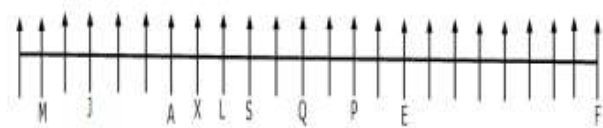

(11-15)

Months	Persons	Payment Mode
March	L	Gpay
May	I	UPI
June	M	RTGS
August	K	Paytm
September	J	NEFT
October	H	Cash

(16-20)

Days	Satellites
Monday	P
Tuesday	Q
Wednesday	R
Thursday	M
Friday	O
Saturday	S
Sunday	N

(21-25)

Floor	Flat P	Flat Q
4	C	E
3	G	Vacant
2	D	A
1	F	B

(26-30)

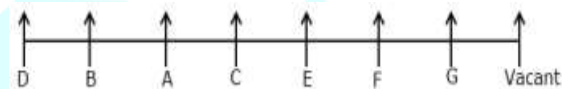

(31-35)

Subjects	Chemistry	Mathematics	Physics
Teachers	I, J, H	G, E, K	F, D

(36-40)

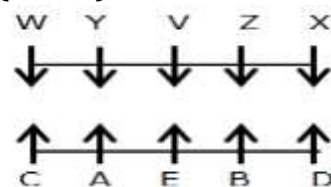

(41-45)

Persons	Vegetables
C	Cabbage
A	Radish
F	Onion
D	Potato
B	Brinjal
E	Carrot



(46-50)

Book
E
A
F
B
G
C
H
D
I

(51-55)

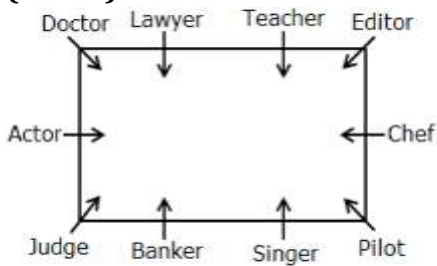

(56-60)

Year	Age	Persons
1974	49	No one
1979	44	P
1983	40	Q
1992	31	S
1997	26	U
2005	18	T
2014	09	R

(61-65)

Position	Case-I	
	Person	Leaves
Chairman	B	21
CEO	A	25
MD	F	23
GM	D	30
Manager	G	32
Assi Manager	C	33
Clerk	E	31

(66-70)

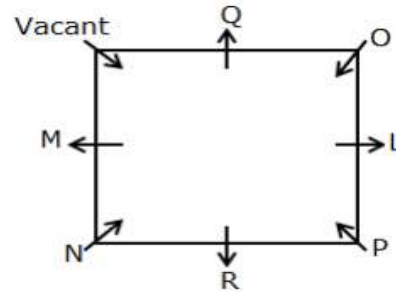

(71-75)

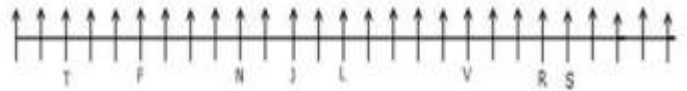

(76-80)

Month	Date	Persons	Instruments
June	6	P	Violin
	19	L	Piano
August	6	O	Trumpet
	19	M	Flute
October	6	N	Drums
	19	Q	Sitar

(81-85)

Days	Person	Games
Monday	L	Tennis
Tuesday	J	Golf
Wednesday	N	Hockey
Thursday	K	Football
Friday	I	Badminton
Saturday	M	Cricket

(86-90)

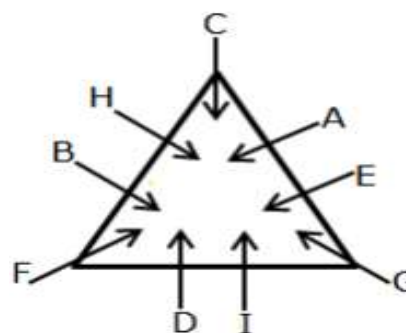

(91-95)

Floors	Persons
8	C
7	D
6	Vacant
5	G
4	B
3	E
2	A
1	F

(96-100)

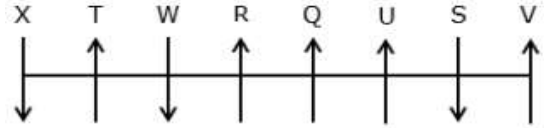

IBPS **RRB PO**
MOCK INTERVIEW
FREE! FREE! FREE!

Get Guidance from Ex. Officers

Call Now : **99 22 41 6666** For Registration

WINNER INSTITUTE Since 2010
India's Best Banking Institute